

Push-pull m12 A code male straight front panel mount connector, unshielded, insert/推拉式M12, A型公头直头前锁面板板端, 不带屏蔽

Scale drawing/尺寸图

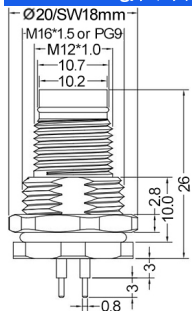

Product photo/产品图



Part number/产品料号

Pins/针数	Code/型	Part number/产品料号	
		PG9 thread 15.3±0.1/PG9螺纹15.3±0.1	M16 thread 16±0.1/M16螺纹16±0.1
3pins/3针	A code/A型	12B385	12B425
4pins/4针	A code/A型	12B389	12B429
5pins/5针	A code/A型	12B393	12B433
8pins/8针	A code/A型	12B397	12B437
12pins/12针	A code/A型	12B401	12B441

Pin assignment front view/针位分布前视图

A code 3pins A型3针 A code 4pins A型4针 A code 5pins A型5针 A code 8pins A型8针 A code 12pins A型12针

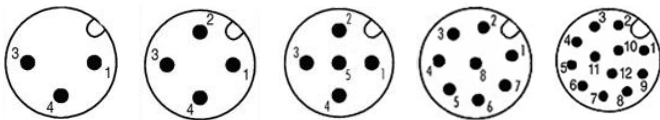

General data/常规数据

Pin Numbers/针数	3pins/3针	4pins/4针	5pins/5针	8pins/8针	12pins/12针
Rated voltage/额定电压	250V		60V	30V	
Rated current(40°C)/额定电流	4A			2A	1.5A
Standards/标准	IEC 61076-2-101				
Termination/焊接方式	Solder PCB/PCB焊接				
Connector locking system/锁紧方式	Push-pull/快锁				
Degree of protection/防护等级	IP67, IP68, IP69K				
Mechanical operation/插拔次数	>100 mating cycles/大于100次				
Ambient temperature (operation)/操作温度	-25°C~+85°C				
Contact resistance/接触电阻	≤5mΩ				
Insulation resistance/绝缘电阻	≥100MΩ				
Connector body/胶芯	TPU				
Pin/端子	Brass with gold plated/黄铜镀金				
Nut and shell/螺母和铜壳	Brass with nickel plated/黄铜镀镍				
Gasket/胶圈	Fluorine ring/氟胶圈				
Customs tariff number/海关编码	8538900000				
Environmental compliance/环境符合标准	RoHs, Reach				

Push-pull m12 A code female straight front panel mount connector, unshielded, insert/推拉式M12, A型母头直头前锁面板板端, 不带屏蔽

Scale drawing/尺寸图

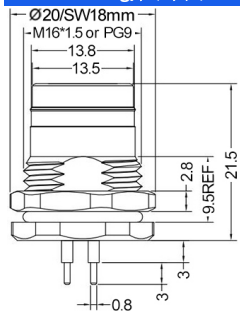

Product photo/产品图



Part number/产品料号

Pins/针数	Code/型	Part number/产品料号	
		PG9 thread 15.3±0.1/PG9螺纹15.3±0.1	M16 thread 16±0.1/M16螺纹16±0.1
3pins/3孔	A code/A型	12B387	12B427
4pins/4孔	A code/A型	12B391	12B431
5pins/5孔	A code/A型	12B395	12B435
8pins/8孔	A code/A型	12B399	12B439
12pins/12孔	A code/A型	12B403	12B443

Pin assignment front view/孔位分布前视图

A code 3pins A型3孔 A code 4pins A型4孔 A code 5pins A型5孔 A code 8pins A型8孔 A code 12pins A型12孔

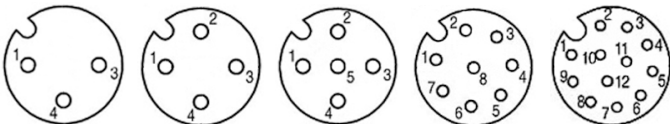

General data/常规数据

Pin Numbers/孔数	3pins/3孔	4pins/4孔	5pins/5孔	8pins/8孔	12pins/12孔
Rated voltage/额定电压	250V		60V	30V	
Rated current(40°C)/额定电流	4A		2A 1.5A		
Standards/标准	IEC 61076-2-101				
Termination/焊接方式	Solder PCB/PCB焊接				
Connector locking system/锁紧方式	Push-pull/快锁				
Degree of protection/防护等级	IP67, IP68, IP69K				
Mechanical operation/插拔次数	>100 mating cycles/大于100次				
Ambient temperature (operation)/操作温度	-25°C~+85°C				
Contact resistance/接触电阻	≤5mΩ				
Insulation resistance/绝缘电阻	≥100MΩ				
Connector body/胶芯	TPU				
Pin/端子	Phosphorus copper with gold plated/磷铜镀金				
Nut and shell/螺母和铜壳	Brass with nickel plated/黄铜镀镍				
Gasket/胶圈	Fluorine ring/氟胶圈				
Customs tariff number/海关编码	8538900000				
Environmental compliance/环境符合标准	RoHS, Reach				

Push-pull m12 A code male straight rear panel mount connector, unshielded, insert/推拉式M12, A型公头直头后锁面板板端, 不带屏蔽

Scale drawing/尺寸图

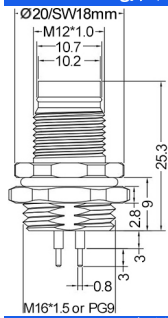

Product photo/产品图



Part number/产品料号

Pins/针数	Code/型	Part number/产品料号	
		PG9 thread 15.3±0.1/PG9螺纹15.3±0.1	M16 thread 16±0.1/M16螺纹16±0.1
3pins/3针	A code/A型	12B386	12B426
4pins/4针	A code/A型	12B390	12B430
5pins/5针	A code/A型	12B394	12B434
8pins/8针	A code/A型	12B398	12B438
12pins/12针	A code/A型	12B402	12B442

Pin assignment front view/针位分布前视图

A code 3pins A型3针 A code 4pins A型4针 A code 5pins A型5针 A code 8pins A型8针 A code 12pins A型12针

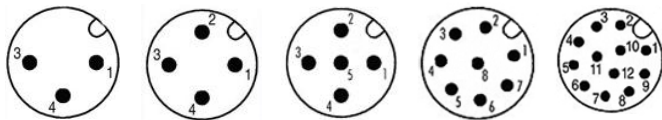

General data/常规数据

Pin Numbers/针数	3pins/3针	4pins/4针	5pins/5针	8pins/8针	12pins/12针
Rated voltage/额定电压	250V		60V	30V	
Rated current(40°C)/额定电流	4A			2A	1.5A
Standards/标准	IEC 61076-2-101				
Termination/焊接方式	Solder PCB/PCB焊接				
Connector locking system/锁紧方式	Push-pull/快锁				
Degree of protection/防护等级	IP67, IP68, IP69K				
Mechanical operation/插拔次数	>100 mating cycles/大于100次				
Ambient temperature (operation)/操作温度	-25°C~+85°C				
Contact resistance/接触电阻	≤5mΩ				
Insulation resistance/绝缘电阻	≥100MΩ				
Connector body/胶芯	TPU				
Pin/端子	Brass with gold plated/黄铜镀金				
Nut and shell/螺母和铜壳	Brass with nickel plated/黄铜镀镍				
Gasket/胶圈	Fluorine ring/氟胶圈				
Customs tariff number/海关编码	8538900000				
Environmental compliance/环境符合标准	RoHs, Reach				

Push-pull m12 A code female straight rear panel mount connector, unshielded, insert/推拉式M12, A型母头直头后锁面板板端, 不带屏蔽

Scale drawing/尺寸图

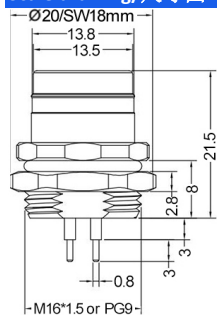

Product photo/产品图



Part number/产品料号

Pins/针数	Code/型	Part number/产品料号	
		PG9 thread 15.3±0.1/PG9螺纹15.3±0.1	M16 thread 16±0.1/M16螺纹16±0.1
3pins/3孔	A code/A型	12B388	12B428
4pins/4孔	A code/A型	12B392	12B432
5pins/5孔	A code/A型	12B396	12B436
8pins/8孔	A code/A型	12B400	12B440
12pins/12孔	A code/A型	12B404	12B444

Pin assignment front view/孔位分布前视图

A code 3pins A型3孔 A code 4pins A型4孔 A code 5pins A型5孔 A code 8pins A型8孔 A code 12pins A型12孔

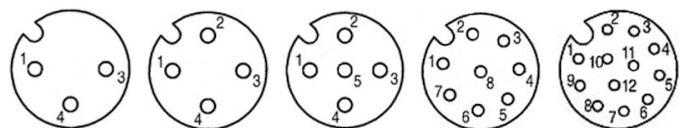

General data/常规数据

Pin Numbers/孔数	3pins/3孔	4pins/4孔	5pins/5孔	8pins/8孔	12pins/12孔
Rated voltage/额定电压	250V		60V	30V	
Rated current(40°C)/额定电流	4A		2A		1.5A
Standards/标准	IEC 61076-2-101				
Termination/焊接方式	Solder PCB/PCB焊接				
Connector locking system/锁紧方式	Push-pull/快锁				
Degree of protection/防护等级	IP67, IP68, IP69K				
Mechanical operation/插拔次数	>100 mating cycles/大于100次				
Ambient temperature (operation)/操作温度	-25°C~+85°C				
Contact resistance/接触电阻	≤5mΩ				
Insulation resistance/绝缘电阻	≥100MΩ				
Connector body/胶芯	TPU				
Pin/端子	Phosphorus copper with gold plated/磷铜镀金				
Nut and shell/螺母和铜壳	Brass with nickel plated/黄铜镀镍				
Gasket/胶圈	Fluorine ring/氟胶圈				
Customs tariff number/海关编码	8538900000				
Environmental compliance/环境符合标准	RoHS, Reach				

Push-pull m12 A code male straight front panel mount connector, shielded, insert/推拉式M12, A型公头直头前锁面板板端, 带屏蔽

Scale drawing/尺寸图

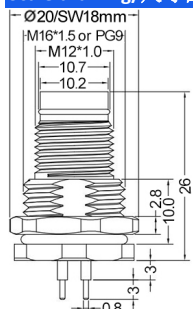

Product photo/产品图



Part number/产品料号

Pins/针数	Code/型	Part number/产品料号	
		PG9 thread 15.3±0.1/PG9螺纹15.3±0.1	M16 thread 16±0.1/M16螺纹16±0.1
3pins/3针	A code/A型	12B405	12B445
4pins/4针	A code/A型	12B409	12B449
5pins/5针	A code/A型	12B413	12B453
8pins/8针	A code/A型	12B417	12B457
12pins/12针	A code/A型	12B421	12B461

Pin assignment front view/针位分布前视图

A code 3pins A型3针 A code 4pins A型4针 A code 5pins A型5针 A code 8pins A型8针 A code 12pins A型12针

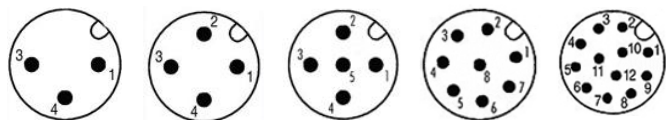

General data/常规数据

Pin Numbers/针数	3pins/3针	4pins/4针	5pins/5针	8pins/8针	12pins/12针
Rated voltage/额定电压	250V		60V	30V	
Rated current(40°C)/额定电流	4A		2A		1.5A
Standards/标准	IEC 61076-2-101				
Termination/焊接方式	Solder PCB/PCB焊接				
Connector locking system/锁紧方式	Push-pull/快锁				
Degree of protection/防护等级	IP67, IP68, IP69K				
Mechanical operation/插拔次数	>100 mating cycles/大于100次				
Ambient temperature (operation)/操作温度	-25°C~+85°C				
Contact resistance/接触电阻	≤5mΩ				
Insulation resistance/绝缘电阻	≥100MΩ				
Connector body/胶芯	TPU				
Pin/端子	Brass with gold plated/黄铜镀金				
Nut and shell/螺母和铜壳	Brass with nickel plated/黄铜镀镍				
Gasket/胶圈	Fluorine ring/氟胶圈				
Customs tariff number/海关编码	8538900000				
Environmental compliance/环境符合标准	RoHs, Reach				

Push-pull m12 A code female straight front panel mount connector, shielded, insert/推拉式M12, A型母头直头前锁面板板端, 带屏蔽

Scale drawing/尺寸图

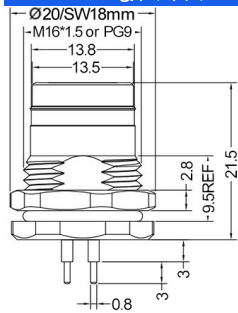

Product photo/产品图



Part number/产品料号

Pins/针数	Code/型	Part number/产品料号	
		PG9 thread 15.3±0.1/PG9螺纹15.3±0.1	M16 thread 16±0.1/M16螺纹16±0.1
3pins/3孔	A code/A型	12B407	12B447
4pins/4孔	A code/A型	12B411	12B451
5pins/5孔	A code/A型	12B415	12B455
8pins/8孔	A code/A型	12B419	12B459
12pins/12孔	A code/A型	12B423	12B463

Pin assignment front view/孔位分布前视图

A code 3pins A型3孔 A code 4pins A型4孔 A code 5pins A型5孔 A code 8pins A型8孔 A code 12pins A型12孔

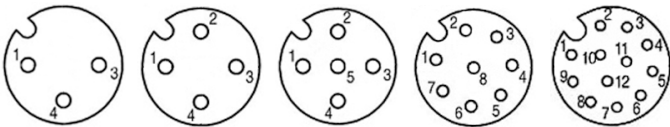

General data/常规数据

Pin Numbers/孔数	3pins/3孔	4pins/4孔	5pins/5孔	8pins/8孔	12pins/12孔
Rated voltage/额定电压	250V		60V	30V	
Rated current(40°C)/额定电流	4A			2A	1.5A
Standards/标准	IEC 61076-2-101				
Termination/焊接方式	Solder PCB/PCB焊接				
Connector locking system/锁紧方式	Push-pull/快锁				
Degree of protection/防护等级	IP67, IP68, IP69K				
Mechanical operation/插拔次数	>100 mating cycles/大于100次				
Ambient temperature (operation)/操作温度	-25°C~+85°C				
Contact resistance/接触电阻	≤5mΩ				
Insulation resistance/绝缘电阻	≥100MΩ				
Connector body/胶芯	TPU				
Pin/端子	Phosphorus copper with gold plated/磷铜镀金				
Nut and shell/螺母和铜壳	Brass with nickel plated/黄铜镀镍				
Gasket/胶圈	Fluorine ring/氟胶圈				
Customs tariff number/海关编码	8538900000				
Environmental compliance/环境符合标准	RoHS, Reach				

Push-pull m12 A code male straight rear panel mount connector, shielded, insert/推拉式M12, A型公头直头后锁面板板端, 带屏蔽

Scale drawing/尺寸图

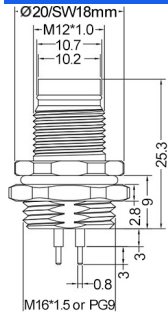

Product photo/产品图



Part number/产品料号

Pins/针数	Code/型	Part number/产品料号	
		PG9 thread 15.3±0.1/PG9螺纹15.3±0.1	M16 thread 16±0.1/M16螺纹16±0.1
3pins/3针	A code/A型	12B406	12B446
4pins/4针	A code/A型	12B410	12B450
5pins/5针	A code/A型	12B414	12B454
8pins/8针	A code/A型	12B418	12B458
12pins/12针	A code/A型	12B422	12B462

Pin assignment front view/针位分布前视图

A code 3pins A型3针 A code 4pins A型4针 A code 5pins A型5针 A code 8pins A型8针 A code 12pins A型12针

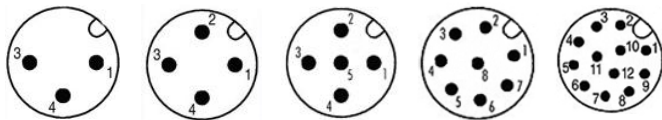

General data/常规数据

Pin Numbers/针数	3pins/3针	4pins/4针	5pins/5针	8pins/8针	12pins/12针
Rated voltage/额定电压	250V		60V	30V	
Rated current(40°C)/额定电流	4A			2A	1.5A
Standards/标准	IEC 61076-2-101				
Termination/焊接方式	Solder PCB/PCB焊接				
Connector locking system/锁紧方式	Push-pull/快锁				
Degree of protection/防护等级	IP67, IP68, IP69K				
Mechanical operation/插拔次数	>100 mating cycles/大于100次				
Ambient temperature (operation)/操作温度	-25°C~+85°C				
Contact resistance/接触电阻	≤5mΩ				
Insulation resistance/绝缘电阻	≥100MΩ				
Connector body/胶芯	TPU				
Pin/端子	Brass with gold plated/黄铜镀金				
Nut and shell/螺母和铜壳	Brass with nickel plated/黄铜镀镍				
Gasket/胶圈	Fluorine ring/氟胶圈				
Customs tariff number/海关编码	8538900000				
Environmental compliance/环境符合标准	RoHS, Reach				

Push-pull m12 A code female straight rear panel mount connector, shielded, insert/推拉式M12, A型母头直头后锁面板板端, 带屏蔽

Scale drawing/尺寸图

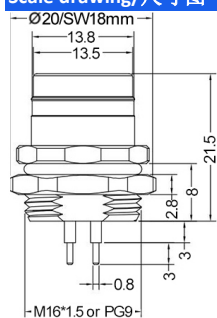

Product photo/产品图



Part number/产品料号

Pins/针数	Code/型	Part number/产品料号	
		PG9 thread 15.3±0.1/PG9螺纹15.3±0.1	M16 thread 16±0.1/M16螺纹16±0.1
3pins/3孔	A code/A型	12B408	12B448
4pins/4孔	A code/A型	12B412	12B452
5pins/5孔	A code/A型	12B416	12B456
8pins/8孔	A code/A型	12B420	12B460
12pins/12孔	A code/A型	12B424	12B464

Pin assignment front view/孔位分布前视图

A code 3pins A型3孔 A code 4pins A型4孔 A code 5pins A型5孔 A code 8pins A型8孔 A code 12pins A型12孔

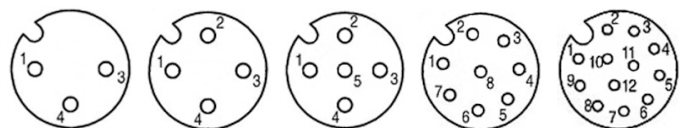

General data/常规数据

Pin Numbers/孔数	3pins/3孔	4pins/4孔	5pins/5孔	8pins/8孔	12pins/12孔
Rated voltage/额定电压	250V		60V	30V	
Rated current(40°C)/额定电流	4A			2A	1.5A
Standards/标准	IEC 61076-2-101				
Termination/焊接方式	Solder PCB/PCB焊接				
Connector locking system/锁紧方式	Push-pull/快锁				
Degree of protection/防护等级	IP67, IP68, IP69K				
Mechanical operation/插拔次数	>100 mating cycles/大于100次				
Ambient temperature (operation)/操作温度	-25°C~+85°C				
Contact resistance/接触电阻	≤5mΩ				
Insulation resistance/绝缘电阻	≥100MΩ				
Connector body/胶芯	TPU				
Pin/端子	Phosphorus copper with gold plated/磷铜镀金				
Nut and shell/螺母和铜壳	Brass with nickel plated/黄铜镀镍				
Gasket/胶圈	Fluorine ring/氟胶圈				
Customs tariff number/海关编码	8538900000				
Environmental compliance/环境符合标准	RoHs, Reach				

Push-pull m12 A code male straight front panel mount connector, unshielded, solder/推拉式M12, A型公头直头前锁面板焊线式, 不带屏蔽

Scale drawing/尺寸图

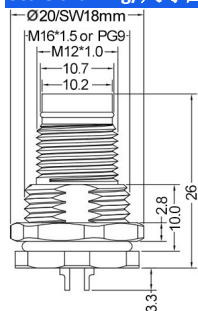

Product photo/产品图



Part number/产品料号

Pins/针数	Code/型	Part number/产品料号	
		PG9 thread 15.3±0.1/PG9螺纹15.3±0.1	M16 thread 16±0.1/M16螺纹16±0.1
3pins/3针	A code/A型	12H228	12H269
4pins/4针	A code/A型	12H232	12H273
5pins/5针	A code/A型	12H236	12H277
8pins/8针	A code/A型	12H240	12H281
12pins/12针	A code/A型	12H244	12H285

Pin assignment front view/针位分布前视图

A code 3pins A型3针 A code 4pins A型4针 A code 5pins A型5针 A code 8pins A型8针 A code 12pins A型12针

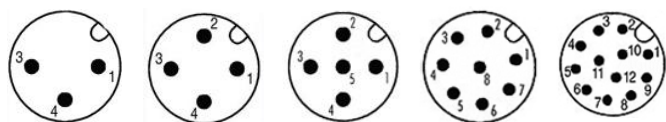

General data/常规数据

Pin Numbers/针数	3pins/3针	4pins/4针	5pins/5针	8pins/8针	12pins/12针
Rated voltage/额定电压	250V		60V	30V	
Rated current(40°C)/额定电流	4A			2A	1.5A
Standards/标准	IEC 61076-2-101				
Termination/焊接方式	Solder PCB/PCB焊接				
Connector locking system/锁紧方式	Push-pull/快锁				
Degree of protection/防护等级	IP67, IP68, IP69K				
Mechanical operation/插拔次数	>100 mating cycles/大于100次				
Ambient temperature (operation)/操作温度	-25°C~+85°C				
Contact resistance/接触电阻	≤5mΩ				
Insulation resistance/绝缘电阻	≥100MΩ				
Connector body/胶芯	TPU				
Pin/端子	Brass with gold plated/黄铜镀金				
Nut and shell/螺母和铜壳	Brass with nickel plated/黄铜镀镍				
Gasket/胶圈	Fluorine ring/氟胶圈				
Customs tariff number/海关编码	8538900000				
Environmental compliance/环境符合标准	RoHs, Reach				

Push-pull m12 A code female straight front panel mount connector, unshielded, solder/推拉式M12, A型母头直头前锁面板焊线式, 不带屏蔽

Scale drawing/尺寸图

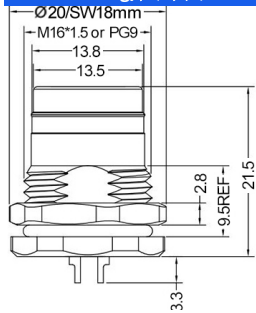

Product photo/产品图



Part number/产品料号

Pins/针数	Code/型	Part number/产品料号	
		PG9 thread 15.3±0.1/PG9螺纹15.3±0.1	M16 thread 16±0.1/M16螺纹16±0.1
3pins/3孔	A code/A型	12H230	12H271
4pins/4孔	A code/A型	12H234	12H275
5pins/5孔	A code/A型	12H238	12H279
8pins/8孔	A code/A型	12H242	12H283
12pins/12孔	A code/A型	12H246	12H287

Pin assignment front view/孔位分布前视图

A code 3pins A型3孔 A code 4pins A型4孔 A code 5pins A型5孔 A code 8pins A型8孔 A code 12pins A型12孔

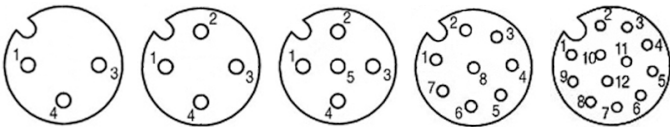

General data/常规数据

Pin Numbers/孔数	3pins/3孔	4pins/4孔	5pins/5孔	8pins/8孔	12pins/12孔
Rated voltage/额定电压	250V		60V	30V	
Rated current(40°C)/额定电流	4A		2A 1.5A		
Standards/标准	IEC 61076-2-101				
Termination/焊接方式	Solder PCB/PCB焊接				
Connector locking system/锁紧方式	Push-pull/快锁				
Degree of protection/防护等级	IP67, IP68, IP69K				
Mechanical operation/插拔次数	>100 mating cycles/大于100次				
Ambient temperature (operation)/操作温度	-25°C~+85°C				
Contact resistance/接触电阻	≤5mΩ				
Insulation resistance/绝缘电阻	≥100MΩ				
Connector body/胶芯	TPU				
Pin/端子	Phosphorus copper with gold plated/磷铜镀金				
Nut and shell/螺母和铜壳	Brass with nickel plated/黄铜镀镍				
Gasket/胶圈	Fluorine ring/氟胶圈				
Customs tariff number/海关编码	8538900000				
Environmental compliance/环境符合标准	RoHS, Reach				

Push-pull m12 A code male straight rear panel mount connector, unshielded, solder/推拉式M12, A型公头直头后锁面板焊线式, 不带屏蔽

Scale drawing/尺寸图

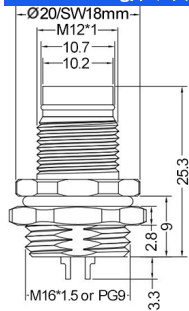

Product photo/产品图



Part number/产品料号

Pins/针数	Code/型	Part number/产品料号	
		PG9 thread 15.3±0.1/PG9螺纹15.3±0.1	M16 thread 16±0.1/M16螺纹16±0.1
3pins/3针	A code/A型	12H229	12H270
4pins/4针	A code/A型	12H233	12H274
5pins/5针	A code/A型	12H237	12H278
8pins/8针	A code/A型	12H241	12H282
12pins/12针	A code/A型	12H245	12H286

Pin assignment front view/针位分布前视图

A code 3pins A型3针 A code 4pins A型4针 A code 5pins A型5针 A code 8pins A型8针 A code 12pins A型12针

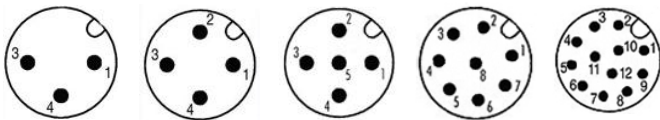

General data/常规数据

Pin Numbers/针数	3pins/3针	4pins/4针	5pins/5针	8pins/8针	12pins/12针
Rated voltage/额定电压	250V		60V	30V	
Rated current(40°C)/额定电流	4A			2A	1.5A
Standards/标准	IEC 61076-2-101				
Termination/焊接方式	Solder PCB/PCB焊接				
Connector locking system/锁紧方式	Push-pull/快锁				
Degree of protection/防护等级	IP67, IP68, IP69K				
Mechanical operation/插拔次数	>100 mating cycles/大于100次				
Ambient temperature (operation)/操作温度	-25°C~+85°C				
Contact resistance/接触电阻	≤5mΩ				
Insulation resistance/绝缘电阻	≥100MΩ				
Connector body/胶芯	TPU				
Pin/端子	Brass with gold plated/黄铜镀金				
Nut and shell/螺母和铜壳	Brass with nickel plated/黄铜镀镍				
Gasket/胶圈	Fluorine ring/氟胶圈				
Customs tariff number/海关编码	8538900000				
Environmental compliance/环境符合标准	RoHs, Reach				

Push-pull m12 A code female straight rear panel mount connector, unshielded, solder/推拉式M12, A型母头直头后锁面板焊线式, 不带屏蔽

Scale drawing/尺寸图

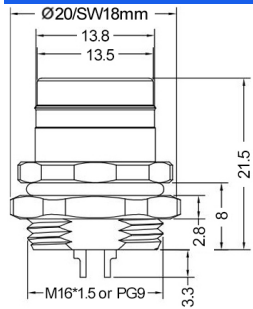

Product photo/产品图



Part number/产品料号

Pins/针数	Code/型	Part number/产品料号	
		PG9 thread 15.3±0.1/PG9螺纹15.3±0.1	M16 thread 16±0.1/M16螺纹16±0.1
3pins/3孔	A code/A型	12H231	12H272
4pins/4孔	A code/A型	12H235	12H276
5pins/5孔	A code/A型	12H239	12H280
8pins/8孔	A code/A型	12H243	12H284
12pins/12孔	A code/A型	12H247	12H288

Pin assignment front view/孔位分布前视图

A code 3pins A型3孔 A code 4pins A型4孔 A code 5pins A型5孔 A code 8pins A型8孔 A code 12pins A型12孔

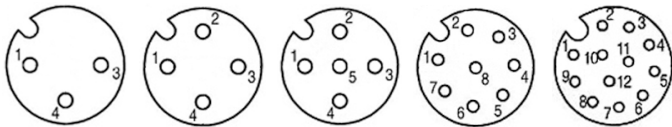

General data/常规数据

Pin Numbers/孔数	3pins/3孔	4pins/4孔	5pins/5孔	8pins/8孔	12pins/12孔
Rated voltage/额定电压	250V		60V	30V	
Rated current(40°C)/额定电流	4A			2A	1.5A
Standards/标准	IEC 61076-2-101				
Termination/焊接方式	Solder PCB/PCB焊接				
Connector locking system/锁紧方式	Push-pull/快锁				
Degree of protection/防护等级	IP67, IP68, IP69K				
Mechanical operation/插拔次数	>100 mating cycles/大于100次				
Ambient temperature (operation)/操作温度	-25°C~+85°C				
Contact resistance/接触电阻	≤5mΩ				
Insulation resistance/绝缘电阻	≥100MΩ				
Connector body/胶芯	TPU				
Pin/端子	Phosphorus copper with gold plated/磷铜镀金				
Nut and shell/螺母和铜壳	Brass with nickel plated/黄铜镀镍				
Gasket/胶圈	Fluorine ring/氟胶圈				
Customs tariff number/海关编码	8538900000				
Environmental compliance/环境符合标准	RoHS, Reach				

Push-pull m12 A code male straight front panel mount connector, shielded, solder/推拉式M12, A型公头直头前锁面板焊线式, 带屏蔽

Scale drawing/尺寸图

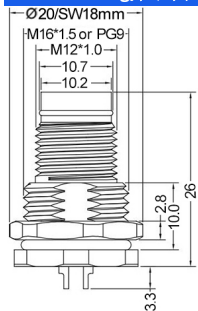

Product photo/产品图



Part number/产品料号

Pins/针数	Code/型	Part number/产品料号	
		PG9 thread 15.3±0.1/PG9螺纹15.3±0.1	M16 thread 16±0.1/M16螺纹16±0.1
3pins/3针	A code/A型	12H248	12H289
4pins/4针	A code/A型	12H252	12H293
5pins/5针	A code/A型	12H256	12H297
8pins/8针	A code/A型	12H260	12H301
12pins/12针	A code/A型	12H264	12H305

Pin assignment front view/针位分布前视图

A code 3pins A型3针 A code 4pins A型4针 A code 5pins A型5针 A code 8pins A型8针 A code 12pins A型12针

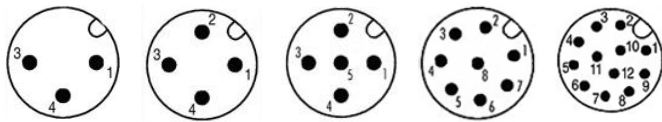

General data/常规数据

Pin Numbers/针数	3pins/3针	4pins/4针	5pins/5针	8pins/8针	12pins/12针
Rated voltage/额定电压	250V		60V	30V	
Rated current(40°C)/额定电流	4A			2A	1.5A
Standards/标准	IEC 61076-2-101				
Termination/焊接方式	Solder PCB/PCB焊接				
Connector locking system/锁紧方式	Push-pull/快锁				
Degree of protection/防护等级	IP67, IP68, IP69K				
Mechanical operation/插拔次数	>100 mating cycles/大于100次				
Ambient temperature (operation)/操作温度	-25°C~+85°C				
Contact resistance/接触电阻	≤5mΩ				
Insulation resistance/绝缘电阻	≥100MΩ				
Connector body/胶芯	TPU				
Pin/端子	Brass with gold plated/黄铜镀金				
Nut and shell/螺母和铜壳	Brass with nickel plated/黄铜镀镍				
Gasket/胶圈	Fluorine ring/氟胶圈				
Customs tariff number/海关编码	8538900000				
Environmental compliance/环境符合标准	RoHs, Reach				

Push-pull m12 A code female straight front panel mount connector, shielded, solder/推拉式M12, A型母头直头前锁面板焊线式, 带屏蔽

Scale drawing/尺寸图

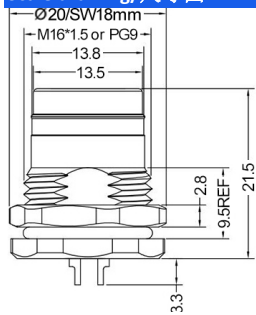

Product photo/产品图



Part number/产品料号

Pins/针数	Code/型	Part number/产品料号	
		PG9 thread 15.3±0.1/PG9螺纹15.3±0.1	M16 thread 16±0.1/M16螺纹16±0.1
3pins/3孔	A code/A型	12H250	12H291
4pins/4孔	A code/A型	12H254	12H295
5pins/5孔	A code/A型	12H258	12H299
8pins/8孔	A code/A型	12H262	12H303
12pins/12孔	A code/A型	12H266	12H307

Pin assignment front view/孔位分布前视图

A code 3pins A型3孔 A code 4pins A型4孔 A code 5pins A型5孔 A code 8pins A型8孔 A code 12pins A型12孔

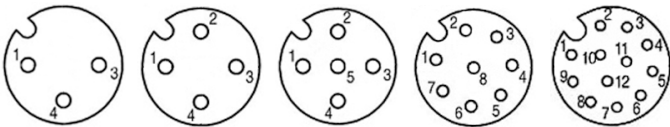

General data/常规数据

Pin Numbers/孔数	3pins/3孔	4pins/4孔	5pins/5孔	8pins/8孔	12pins/12孔
Rated voltage/额定电压	250V		60V	30V	
Rated current(40°C)/额定电流	4A		2A 1.5A		
Standards/标准	IEC 61076-2-101				
Termination/焊接方式	Solder PCB/PCB焊接				
Connector locking system/锁紧方式	Push-pull/快锁				
Degree of protection/防护等级	IP67, IP68, IP69K				
Mechanical operation/插拔次数	>100 mating cycles/大于100次				
Ambient temperature (operation)/操作温度	-25°C~+85°C				
Contact resistance/接触电阻	≤5mΩ				
Insulation resistance/绝缘电阻	≥100MΩ				
Connector body/胶芯	TPU				
Pin/端子	Phosphorus copper with gold plated/磷铜镀金				
Nut and shell/螺母和铜壳	Brass with nickel plated/黄铜镀镍				
Gasket/胶圈	Fluorine ring/氟胶圈				
Customs tariff number/海关编码	8538900000				
Environmental compliance/环境符合标准	RoHs, Reach				

Push-pull m12 A code male straight rear panel mount connector, shielded, solder/推拉式M12, A型公头直头后锁面板焊线式, 带屏蔽

Scale drawing/尺寸图

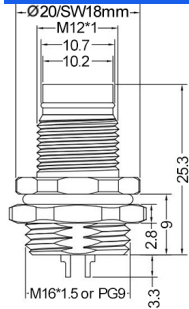

Product photo/产品图



Part number/产品料号

Pins/针数	Code/型	Part number/产品料号	
		PG9 thread 15.3±0.1/PG9螺纹15.3±0.1	M16 thread 16±0.1/M16螺纹16±0.1
3pins/3针	A code/A型	12H249	12H290
4pins/4针	A code/A型	12H253	12H294
5pins/5针	A code/A型	12H257	12H298
8pins/8针	A code/A型	12H261	12H302
12pins/12针	A code/A型	12H265	12H306

Pin assignment front view/针位分布前视图

A code 3pins A型3针 A code 4pins A型4针 A code 5pins A型5针 A code 8pins A型8针 A code 12pins A型12针

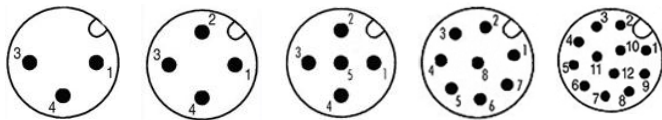

General data/常规数据

Pin Numbers/针数	3pins/3针	4pins/4针	5pins/5针	8pins/8针	12pins/12针
Rated voltage/额定电压	250V		60V	30V	
Rated current(40°C)/额定电流	4A			2A	1.5A
Standards/标准	IEC 61076-2-101				
Termination/焊接方式	Solder PCB/PCB焊接				
Connector locking system/锁紧方式	Push-pull/快锁				
Degree of protection/防护等级	IP67, IP68, IP69K				
Mechanical operation/插拔次数	>100 mating cycles/大于100次				
Ambient temperature (operation)/操作温度	-25°C~+85°C				
Contact resistance/接触电阻	≤5mΩ				
Insulation resistance/绝缘电阻	≥100MΩ				
Connector body/胶芯	TPU				
Pin/端子	Brass with gold plated/黄铜镀金				
Nut and shell/螺母和铜壳	Brass with nickel plated/黄铜镀镍				
Gasket/胶圈	Fluorine ring/氟胶圈				
Customs tariff number/海关编码	8538900000				
Environmental compliance/环境符合标准	RoHs, Reach				

Push-pull m12 A code female straight rear panel mount connector, shielded, solder/推拉式M12, A型母头直头后锁面板焊线式, 带屏蔽

Scale drawing/尺寸图

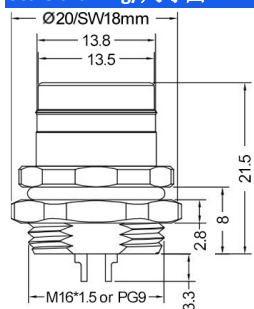

Product photo/产品图



Part number/产品料号

Pins/针数	Code/型	Part number/产品料号	
		PG9 thread 15.3±0.1/PG9螺纹15.3±0.1	M16 thread 16±0.1/M16螺纹16±0.1
3pins/3孔	A code/A型	12H251	12H292
4pins/4孔	A code/A型	12H255	12H296
5pins/5孔	A code/A型	12H259	12H300
8pins/8孔	A code/A型	12H263	12H304
12pins/12孔	A code/A型	12H267	12H308

Pin assignment front view/孔位分布前视图

A code 3pins A型3孔 A code 4pins A型4孔 A code 5pins A型5孔 A code 8pins A型8孔 A code 12pins A型12孔

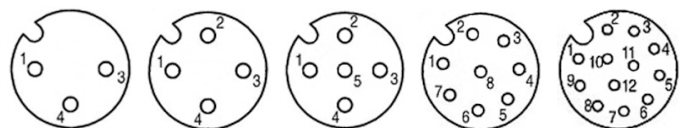

General data/常规数据

Pin Numbers/孔数	3pins/3孔	4pins/4孔	5pins/5孔	8pins/8孔	12pins/12孔
Rated voltage/额定电压	250V		60V	30V	
Rated current(40°C)/额定电流	4A		2A 1.5A		
Standards/标准	IEC 61076-2-101				
Termination/焊接方式	Solder PCB/PCB焊接				
Connector locking system/锁紧方式	Push-pull/快锁				
Degree of protection/防护等级	IP67, IP68, IP69K				
Mechanical operation/插拔次数	>100 mating cycles/大于100次				
Ambient temperature (operation)/操作温度	-25°C~+85°C				
Contact resistance/接触电阻	≤5mΩ				
Insulation resistance/绝缘电阻	≥100MΩ				
Connector body/胶芯	TPU				
Pin/端子	Phosphorus copper with gold plated/磷铜镀金				
Nut and shell/螺母和铜壳	Brass with nickel plated/黄铜镀镍				
Gasket/胶圈	Fluorine ring/氟胶圈				
Customs tariff number/海关编码	8538900000				
Environmental compliance/环境符合标准	RoHs, Reach				

Push-pull m12 A code male straight front panel mount connector, unshielded, single wires/推拉式M12, A型公头直头前锁面板带线, 不带屏蔽

Scale drawing/尺寸图

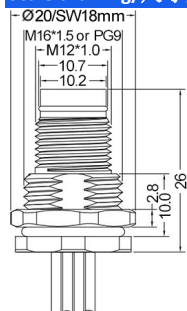

Product photo/产品图



Part number/产品料号

Pins/针数	Code/型	Part number/产品料号	
		PG9 thread 15.3±0.1/PG9螺纹15.3±0.1	M16 thread 16±0.1/M16螺纹16±0.1
2pins/2针	A code/A型	12D494	
3pins/3针	A code/A型	12D499	12D515
4pins/4针	A code/A型	12D503	12D519
5pins/5针	A code/A型	12D507	12D523
8pins/8针	A code/A型	12D509	12D527
12pins/12针	A code/A型	12D511	12D531

Pin assignment front view/针位分布前视图

A code 3pins A型3针 A code 4pins A型4针 A code 5pins A型5针 A code 8pins A型8针 A code 12pins A型12针

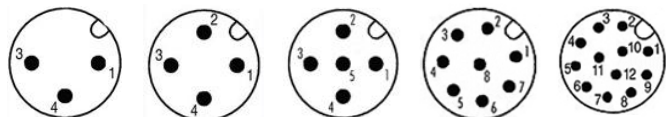

General data/常规数据

Pin Numbers/针数	3pins/3针	4pins/4针	5pins/5针	8pins/8针	12pins/12针
Rated voltage/额定电压	250V		60V	30V	
Rated current(40°C)/额定电流	4A			2A	1.5A
Standards/标准	IEC 61076-2-101				
Termination/焊接方式	Solder PCB/PCB焊接				
Connector locking system/锁紧方式	Push-pull/快锁				
Degree of protection/防护等级	IP67, IP68, IP69K				
Mechanical operation/插拔次数	>100 mating cycles/大于100次				
Ambient temperature (operation)/操作温度	-25°C~+85°C				
Contact resistance/接触电阻	≤5mΩ				
Insulation resistance/绝缘电阻	≥100MΩ				
Connector body/胶芯	TPU				
Pin/端子	Brass with gold plated/黄铜镀金				
Nut and shell/螺母和铜壳	Brass with nickel plated/黄铜镀镍				
Gasket/胶圈	Fluorine ring/氟胶圈				
Customs tariff number/海关编码	8538900000				
Environmental compliance/环境符合标准	RoHs, Reach				

Push-pull m12 A code female straight front panel mount connector, unshielded, single wires/推拉式M12, A型母头直头前锁面板带线, 不带屏蔽

Scale drawing/尺寸图

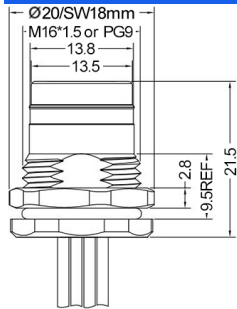

Product photo/产品图



Part number/产品料号

Pins/孔数	Code/型	Part number/产品料号	
		PG9 thread 15.3±0.1/PG9螺纹15.3±0.1	M16 thread 16±0.1/M16螺纹16±0.1
2pins/2孔	A code/A型	12D495	
3pins/3孔	A code/A型	12D501	12D517
4pins/4孔	A code/A型	12D505	12D521
5pins/5孔	A code/A型	12D489	12D525
8pins/8孔	A code/A型	12D491	12D529
12pins/12孔	A code/A型	12D513	12D533

Pin assignment front view/孔位分布前视图

A code 3pins A型3孔 A code 4pins A型4孔 A code 5pins A型5孔 A code 8pins A型8孔 A code 12pins A型12孔

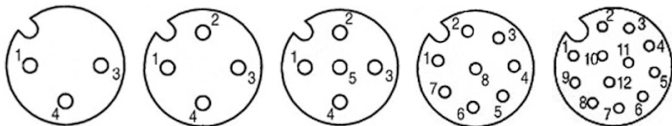

General data/常规数据

Pin Numbers/孔数	3pins/3孔	4pins/4孔	5pins/5孔	8pins/8孔	12pins/12孔
Rated voltage/额定电压	250V		60V	30V	
Rated current(40°C)/额定电流	4A			2A	1.5A
Standards/标准	IEC 61076-2-101				
Termination/焊接方式	Solder PCB/PCB焊接				
Connector locking system/锁紧方式	Push-pull/快锁				
Degree of protection/防护等级	IP67, IP68, IP69K				
Mechanical operation/插拔次数	>100 mating cycles/大于100次				
Ambient temperature (operation)/操作温度	-25°C~+85°C				
Contact resistance/接触电阻	≤5mΩ				
Insulation resistance/绝缘电阻	≥100MΩ				
Connector body/胶芯	TPU				
Pin/端子	Phosphorus copper with gold plated/磷铜镀金				
Nut and shell/螺母和铜壳	Brass with nickel plated/黄铜镀镍				
Gasket/胶圈	Fluorine ring/氟胶圈				
Customs tariff number/海关编码	8538900000				
Environmental compliance/环境符合标准	RoHs, Reach				

Push-pull m12 A code male straight rear panel mount connector, unshielded, single wires/推拉式M12, A型公头直头后锁面板带线, 不带屏蔽

Scale drawing/尺寸图

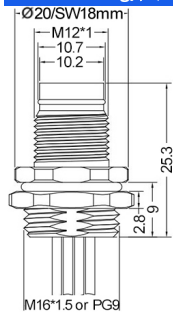

Product photo/产品图



Part number/产品料号

Pins/针数	Code/型	Part number/产品料号	
		PG9 thread 15.3±0.1/PG9螺纹15.3±0.1	M16 thread 16±0.1/M16螺纹16±0.1
3pins/3针	A code/A型	12D500	12D516
4pins/4针	A code/A型	12D504	12D520
5pins/5针	A code/A型	12D508	12D524
8pins/8针	A code/A型	12D510	12D528
12pins/12针	A code/A型	12D512	12D532

Pin assignment front view/针位分布前视图

A code 3pins A型3针 A code 4pins A型4针 A code 5pins A型5针 A code 8pins A型8针 A code 12pins A型12针

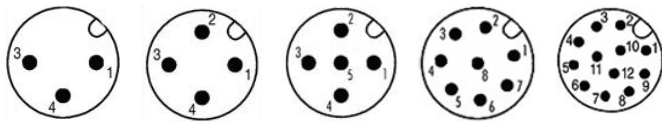

General data/常规数据

Pin Numbers/针数	3pins/3针	4pins/4针	5pins/5针	8pins/8针	12pins/12针
Rated voltage/额定电压	250V		60V	30V	
Rated current(40°C)/额定电流	4A			2A	1.5A
Standards/标准	IEC 61076-2-101				
Termination/焊接方式	Solder PCB/PCB焊接				
Connector locking system/锁紧方式	Push-pull/快锁				
Degree of protection/防护等级	IP67, IP68, IP69K				
Mechanical operation/插拔次数	>100 mating cycles/大于100次				
Ambient temperature (operation)/操作温度	-25°C~+85°C				
Contact resistance/接触电阻	≤5mΩ				
Insulation resistance/绝缘电阻	≥100MΩ				
Connector body/胶芯	TPU				
Pin/端子	Brass with gold plated/黄铜镀金				
Nut and shell/螺母和铜壳	Brass with nickel plated/黄铜镀镍				
Gasket/胶圈	Fluorine ring/氟胶圈				
Customs tariff number/海关编码	8538900000				
Environmental compliance/环境符合标准	RoHS, Reach				

Push-pull m12 A code female straight rear panel mount connector, unshielded, single wires/推拉式M12, A型母头直头后锁面板带线, 不带屏蔽

Scale drawing/尺寸图

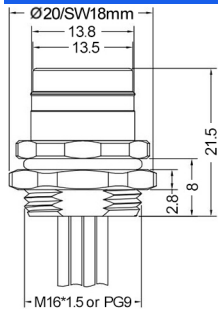

Product photo/产品图

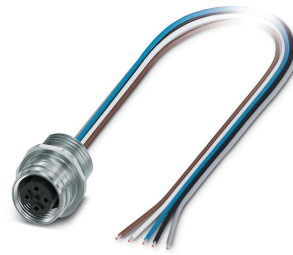

Part number/产品料号

Pins/孔数	Code/型	Part number/产品料号	
		PG9 thread 15.3±0.1/PG9螺纹15.3±0.1	M16 thread 16±0.1/M16螺纹16±0.1
3pins/3孔	A code/A型	12D502	12D518
4pins/4孔	A code/A型	12D506	12D522
5pins/5孔	A code/A型	12D490	12D526
8pins/8孔	A code/A型	12D492	12D530
12pins/12孔	A code/A型	12D514	12D534

Pin assignment front view/孔位分布前视图

A code 3pins A型3孔 A code 4pins A型4孔 A code 5pins A型5孔 A code 8pins A型8孔 A code 12pins A型12孔

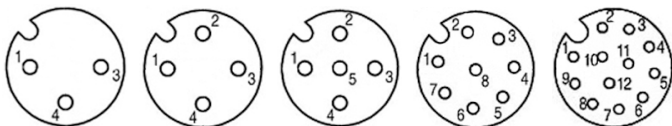

General data/常规数据

Pin Numbers/孔数	3pins/3孔	4pins/4孔	5pins/5孔	8pins/8孔	12pins/12孔
Rated voltage/额定电压	250V		60V	30V	
Rated current(40°C)/额定电流	4A		2A 1.5A		
Standards/标准	IEC 61076-2-101				
Termination/焊接方式	Solder PCB/PCB焊接				
Connector locking system/锁紧方式	Push-pull/快锁				
Degree of protection/防护等级	IP67, IP68, IP69K				
Mechanical operation/插拔次数	>100 mating cycles/大于100次				
Ambient temperature (operation)/操作温度	-25°C~+85°C				
Contact resistance/接触电阻	≤5mΩ				
Insulation resistance/绝缘电阻	≥100MΩ				
Connector body/胶芯	TPU				
Pin/端子	Phosphorus copper with gold plated/磷铜镀金				
Nut and shell/螺母和铜壳	Brass with nickel plated/黄铜镀镍				
Gasket/胶圈	Fluorine ring/氟胶圈				
Customs tariff number/海关编码	8538900000				
Environmental compliance/环境符合标准	RoHs, Reach				

Push-pull m12 A code male straight front panel mount connector, shielded, single wires/推拉式M12, A型公头直头前锁面板带线, 带屏蔽

Scale drawing/尺寸图

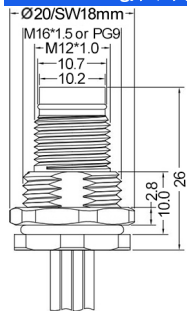

Product photo/产品图



Part number/产品料号

Pins/针数	Code/型	Part number/产品料号	
		PG9 thread 15.3±0.1/PG9螺纹15.3±0.1	M16 thread 16±0.1/M16螺纹16±0.1
3pins/3针	A code/A型	12D535	12D555
4pins/4针	A code/A型	12D539	12D559
5pins/5针	A code/A型	12D543	12D563
8pins/8针	A code/A型	12D547	12D567
12pins/12针	A code/A型	12D551	12D571

Pin assignment front view/针位分布前视图

A code 3pins A code 4pins A code 5pins A code 8pins A code 12pins
A型3针 A型4针 A型5针 A型8针 A型12针

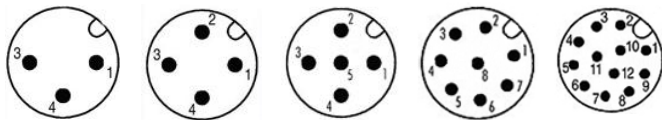

General data/常规数据

Pin Numbers/针数	3pins/3针	4pins/4针	5pins/5针	8pins/8针	12pins/12针
Rated voltage/额定电压	250V		60V	30V	
Rated current(40°C)/额定电流	4A			2A	1.5A
Standards/标准	IEC 61076-2-101				
Termination/焊接方式	Solder PCB/PCB焊接				
Connector locking system/锁紧方式	Push-pull/快锁				
Degree of protection/防护等级	IP67, IP68, IP69K				
Mechanical operation/插拔次数	>100 mating cycles/大于100次				
Ambient temperature (operation)/操作温度	-25°C~+85°C				
Contact resistance/接触电阻	≤5mΩ				
Insulation resistance/绝缘电阻	≥100MΩ				
Connector body/胶芯	TPU				
Pin/端子	Brass with gold plated/黄铜镀金				
Nut and shell/螺母和铜壳	Brass with nickel plated/黄铜镀镍				
Gasket/胶圈	Fluorine ring/氟胶圈				
Customs tariff number/海关编码	8538900000				
Environmental compliance/环境符合标准	RoHS, Reach				

Push-pull m12 A code female straight front panel mount connector, shielded, single wires/推拉式M12, A型母头直头前锁面板带线, 带屏蔽

Scale drawing/尺寸图

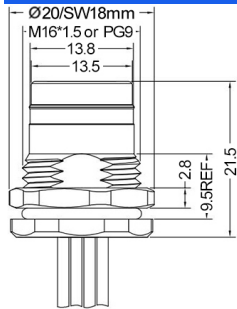

Product photo/产品图



Part number/产品料号

Pins/孔数	Code/型	Part number/产品料号	
		PG9 thread 15.3±0.1/PG9螺纹15.3±0.1	M16 thread 16±0.1/M16螺纹16±0.1
3pins/3孔	A code/A型	12D537	12D557
4pins/4孔	A code/A型	12D541	12D561
5pins/5孔	A code/A型	12D545	12D565
8pins/8孔	A code/A型	12D549	12D569
12pins/12孔	A code/A型	12D553	12D573

Pin assignment front view/孔位分布前视图

A code 3pins A型3孔 A code 4pins A型4孔 A code 5pins A型5孔 A code 8pins A型8孔 A code 12pins A型12孔

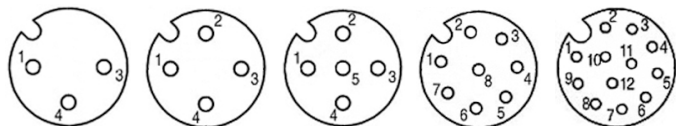

General data/常规数据

Pin Numbers/孔数	3pins/3孔	4pins/4孔	5pins/5孔	8pins/8孔	12pins/12孔
Rated voltage/额定电压	250V		60V	30V	
Rated current(40°C)/额定电流	4A		2A 1.5A		
Standards/标准	IEC 61076-2-101				
Termination/焊接方式	Solder PCB/PCB焊接				
Connector locking system/锁紧方式	Push-pull/快锁				
Degree of protection/防护等级	IP67, IP68, IP69K				
Mechanical operation/插拔次数	>100 mating cycles/大于100次				
Ambient temperature (operation)/操作温度	-25°C~+85°C				
Contact resistance/接触电阻	≤5mΩ				
Insulation resistance/绝缘电阻	≥100MΩ				
Connector body/胶芯	TPU				
Pin/端子	Phosphorus copper with gold plated/磷铜镀金				
Nut and shell/螺母和铜壳	Brass with nickel plated/黄铜镀镍				
Gasket/胶圈	Fluorine ring/氟胶圈				
Customs tariff number/海关编码	8538900000				
Environmental compliance/环境符合标准	RoHs, Reach				

Push-pull m12 A code male straight rear panel mount connector, shielded, single wires/推拉式M12, A型公头直头后锁面板带线, 带屏蔽

Scale drawing/尺寸图

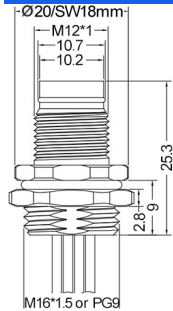

Product photo/产品图



Part number/产品料号

Pins/针数	Code/型	Part number/产品料号	
		PG9 thread 15.3±0.1/PG9螺纹15.3±0.1	M16 thread 16±0.1/M16螺纹16±0.1
3pins/3针	A code/A型	12D536	12D556
4pins/4针	A code/A型	12D540	12D560
5pins/5针	A code/A型	12D544	12D564
8pins/8针	A code/A型	12D548	12D568
12pins/12针	A code/A型	12D552	12D572

Pin assignment front view/针位分布前视图

A code 3pins A型3针 A code 4pins A型4针 A code 5pins A型5针 A code 8pins A型8针 A code 12pins A型12针

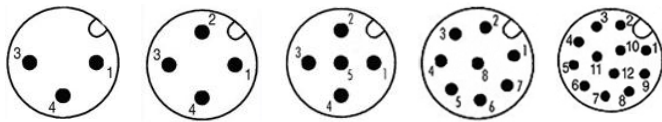

General data/常规数据

Pin Numbers/针数	3pins/3针	4pins/4针	5pins/5针	8pins/8针	12pins/12针
Rated voltage/额定电压	250V		60V	30V	
Rated current(40°C)/额定电流	4A			2A	1.5A
Standards/标准	IEC 61076-2-101				
Termination/焊接方式	Solder PCB/PCB焊接				
Connector locking system/锁紧方式	Push-pull/快锁				
Degree of protection/防护等级	IP67, IP68, IP69K				
Mechanical operation/插拔次数	>100 mating cycles/大于100次				
Ambient temperature (operation)/操作温度	-25°C~+85°C				
Contact resistance/接触电阻	≤5mΩ				
Insulation resistance/绝缘电阻	≥100MΩ				
Connector body/胶芯	TPU				
Pin/端子	Brass with gold plated/黄铜镀金				
Nut and shell/螺母和铜壳	Brass with nickel plated/黄铜镀镍				
Gasket/胶圈	Fluorine ring/氟胶圈				
Customs tariff number/海关编码	8538900000				
Environmental compliance/环境符合标准	RoHs, Reach				

Push-pull m12 A code female straight rear panel mount connector, shielded, single wires/推拉式M12, A型母头直头后锁面板带线, 带屏蔽

Scale drawing/尺寸图

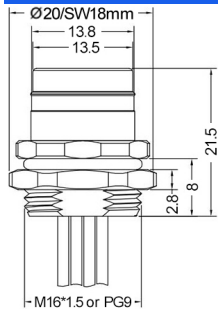

Product photo/产品图

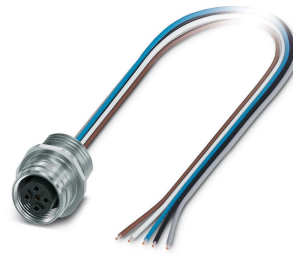

Part number/产品料号

Pins/孔数	Code/型	Part number/产品料号	
		PG9 thread 15.3±0.1/PG9螺纹15.3±0.1	M16 thread 16±0.1/M16螺纹16±0.1
3pins/3孔	A code/A型	12D538	12D558
4pins/4孔	A code/A型	12D542	12D562
5pins/5孔	A code/A型	12D546	12D566
8pins/8孔	A code/A型	12D550	12D570
12pins/12孔	A code/A型	12D554	12D574

Pin assignment front view/孔位分布前视图

A code 3pins A型3孔 A code 4pins A型4孔 A code 5pins A型5孔 A code 8pins A型8孔 A code 12pins A型12孔

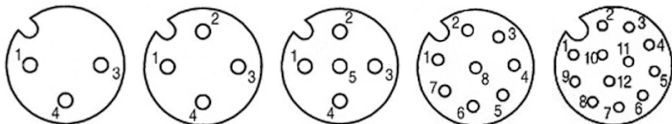

General data/常规数据

Pin Numbers/孔数	3pins/3孔	4pins/4孔	5pins/5孔	8pins/8孔	12pins/12孔
Rated voltage/额定电压	250V		60V	30V	
Rated current(40°C)/额定电流	4A		2A 1.5A		
Standards/标准	IEC 61076-2-101				
Termination/焊接方式	Solder PCB/PCB焊接				
Connector locking system/锁紧方式	Push-pull/快锁				
Degree of protection/防护等级	IP67, IP68, IP69K				
Mechanical operation/插拔次数	>100 mating cycles/大于100次				
Ambient temperature (operation)/操作温度	-25°C~+85°C				
Contact resistance/接触电阻	≤5mΩ				
Insulation resistance/绝缘电阻	≥100MΩ				
Connector body/胶芯	TPU				
Pin/端子	Phosphorus copper with gold plated/磷铜镀金				
Nut and shell/螺母和铜壳	Brass with nickel plated/黄铜镀镍				
Gasket/胶圈	Fluorine ring/氟胶圈				
Customs tariff number/海关编码	8538900000				
Environmental compliance/环境符合标准	RoHs, Reach				

Push-pull m12 A code male straight molded cable, unshielded/推拉式M12, A型公头直头成型式连接线, 不带屏蔽

Scale drawing/尺寸图



Product photo/产品图



Part number/产品料号

Pins/针数	Code/型	Part number("X" is length millimetre mm)/产品料号("X"表示长度, 单位毫米mm)	
		PVC jacket/PVC外被 -40°C~+105°C	PUR jacket/PUR外被 -40°C~+105°C
3pins/3针	A code/A型	12L01828	12L01829
4pins/4针	A code/A型	12L02128	12L01837
5pins/5针	A code/A型	12L01844	12L01845
8pins/8针	A code/A型	12L01852	12L01853
12pins/12针	A code/A型	12L01860	12L01861

Pin assignment front view/针位分布前视图

A code 3pins A code 4pins A code 5pins A code 8pins A code 12pins
A型3针 A型4针 A型5针 A型8针 A型12针

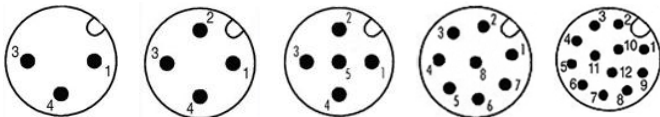

General data/常规数据

Pin Numbers/针数	3pins/3针	4pins/4针	5pins/5针	8pins/8针	12pins/12针
Rated voltage/额定电压	250V		60V	30V	
Rated current(40°C)/额定电流	4A			2A	1.5A
Standards/标准	IEC 61076-2-101				
Termination/焊接方式	Solder PCB/PCB焊接				
Connector locking system/锁紧方式	Push-pull/快锁				
Degree of protection/防护等级	IP67, IP68, IP69K				
Mechanical operation/插拔次数	>100 mating cycles/大于100次				
Ambient temperature (operation)/操作温度	-25°C~+85°C				
Contact resistance/接触电阻	≤5mΩ				
Insulation resistance/绝缘电阻	≥100MΩ				
Connector body/胶芯	TPU				
Pin/端子	Brass with gold plated/黄铜镀金				
Screw/螺丝	Brass with nickel plated/黄铜镀镍				
Over-mold/成型	TPU				
Customs tariff number/海关编码	8518900001				
Environmental compliance/环境符合标准	RoHs, Reach				

Push-pull m12 A code female straight molded cable, unshielded/推拉式M12, A型母头直头成型式连接线, 不带屏蔽

Scale drawing/尺寸图

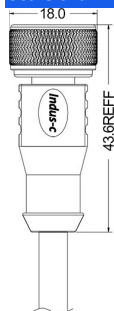

Product photo/产品图



Part number/产品料号

Pins/针数	Code/型	Part number("X" is length millimetre mm)/产品料号("X"表示长度, 单位毫米mm)	
		PVC jacket/PVC外被 -40°C~+105°C	PUR jacket/PUR外被 -40°C~+105°C
3pins/3针	A code/A型	12L01830	12L01831
4pins/4针	A code/A型	12L01838	12L01839
5pins/5针	A code/A型	12L01846	12L01847
8pins/8针	A code/A型	12L01854	12L01855
12pins/12针	A code/A型	12L01862	12L01863

Pin assignment front view/针位分布前视图

A code 3pins A code 4pins A code 5pins A code 8pins A code 12pins
A型3孔 A型4孔 A型5孔 A型8孔 A型12孔

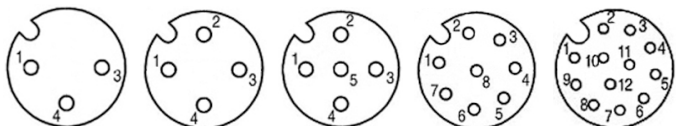

General data/常规数据

Pin Numbers/孔数	3pins/3孔	4pins/4孔	5pins/5孔	8pins/8孔	12pins/12孔
Rated voltage/额定电压	250V		60V	30V	
Rated current(40°C)/额定电流	4A			2A	1.5A
Standards/标准	IEC 61076-2-101				
Termination/焊接方式	Solder PCB/PCB焊接				
Connector locking system/锁紧方式	Push-pull/快锁				
Degree of protection/防护等级	IP67, IP68, IP69K				
Mechanical operation/插拔次数	>100 mating cycles/大于100次				
Ambient temperature (operation)/操作温度	-25°C~+85°C				
Contact resistance/接触电阻	≤5mΩ				
Insulation resistance/绝缘电阻	≥100MΩ				
Connector body/胶芯	TPU				
Pin/端子	Phosphorus copper with gold plated/磷铜镀金				
Screw/螺丝	Brass with nickel plated/黄铜镀镍				
Over-mold/成型	TPU				
Gasket/胶圈	Fluorine ring/氟胶圈				
Customs tariff number/海关编码	8518900001				
Environmental compliance/环境符合标准	RoHs, Reach				

Push-pull m12 A code male right angle molded cable, unshielded/推拉式M12, A型公头弯头成型式连接线, 不带屏蔽

Scale drawing/尺寸图

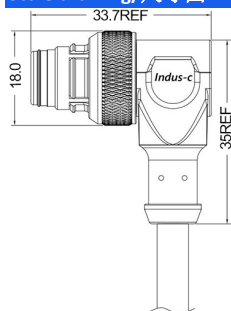

Product photo/产品图



Part number/产品料号

Pins/针数	Code/型	Part number("X" is length millimetre mm)/产品料号("X"表示长度, 单位毫米mm)	
		PVC jacket/PVC外被 -40°C~+105°C	PUR jacket/PUR外被 -40°C~+105°C
3pins/3针	A code/A型	12L01832	12L01833
4pins/4针	A code/A型	12L01840	12L01841
5pins/5针	A code/A型	12L01848	12L01849
8pins/8针	A code/A型	12L01856	12L01857
12pins/12针	A code/A型	12L01864	12L01865

Pin assignment front view/针位分布前视图

A code 3pins A型3针 A code 4pins A型4针 A code 5pins A型5针 A code 8pins A型8针 A code 12pins A型12针

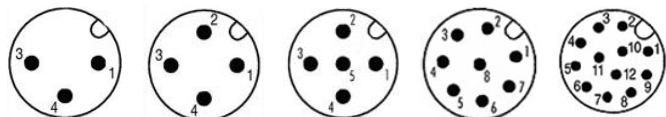

General data/常规数据

Pin Numbers/针数	3pins/3针	4pins/4针	5pins/5针	8pins/8针	12pins/12针
Rated voltage/额定电压	250V		60V	30V	
Rated current(40°C)/额定电流	4A			2A	1.5A
Standards/标准	IEC 61076-2-101				
Termination/焊接方式	Solder PCB/PCB焊接				
Connector locking system/锁紧方式	Push-pull/快锁				
Degree of protection/防护等级	IP67, IP68, IP69K				
Mechanical operation/插拔次数	>100 mating cycles/大于100次				
Ambient temperature (operation)/操作温度	-25°C~+85°C				
Contact resistance/接触电阻	≤5mΩ				
Insulation resistance/绝缘电阻	≥100MΩ				
Connector body/胶芯	TPU				
Pin/端子	Brass with gold plated/黄铜镀金				
Screw/螺丝	Brass with nickel plated/黄铜镀镍				
Over-mold/成型	TPU				
Customs tariff number/海关编码	8518900001				
Environmental compliance/环境符合标准	RoHs, Reach				

Push-pull m12 A code female right angle molded cable, unshielded/推拉式M12, A型母头弯头成型式连接线, 不带屏蔽

Scale drawing/尺寸图

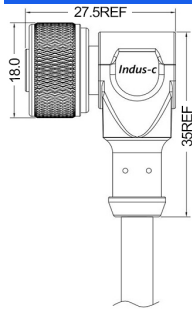

Product photo/产品图



Part number/产品料号

Pins/针数	Code/型	Part number("X" is length millimetre mm)/产品料号("X"表示长度, 单位毫米mm)	
		PVC jacket/PVC外被 -40°C~+105°C	PUR jacket/PUR外被 -40°C~+105°C
3pins/3针	A code/A型	12L01834	12L01835
4pins/4针	A code/A型	12L01842	12L01843
5pins/5针	A code/A型	12L01850	12L01851
8pins/8针	A code/A型	12L01858	12L01859
12pins/12针	A code/A型	12L01866	12L01867

Pin assignment front view/针位分布前视图

A code 3pins A型3孔 A code 4pins A型4孔 A code 5pins A型5孔 A code 8pins A型8孔 A code 12pins A型12孔

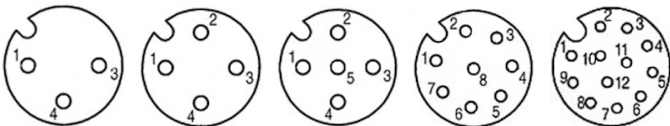

General data/常规数据

Pin Numbers/孔数	3pins/3孔	4pins/4孔	5pins/5孔	8pins/8孔	12pins/12孔
Rated voltage/额定电压	250V		60V	30V	
Rated current(40°C)/额定电流	4A			2A	1.5A
Standards/标准	IEC 61076-2-101				
Termination/焊接方式	Solder PCB/PCB焊接				
Connector locking system/锁紧方式	Push-pull/快锁				
Degree of protection/防护等级	IP67, IP68, IP69K				
Mechanical operation/插拔次数	>100 mating cycles/大于100次				
Ambient temperature (operation)/操作温度	-25°C~+85°C				
Contact resistance/接触电阻	≤5mΩ				
Insulation resistance/绝缘电阻	≥100MΩ				
Connector body/胶芯	TPU				
Pin/端子	Phosphorus copper with gold plated/磷铜镀金				
Screw/螺丝	Brass with nickel plated/黄铜镀镍				
Over-mold/成型	TPU				
Gasket/胶圈	Fluorine ring/氟胶圈				
Customs tariff number/海关编码	8518900001				
Environmental compliance/环境符合标准	RoHs, Reach				

Push-pull m12 A code male to male right angle molded cable, unshielded/推拉式M12, A型公头弯头对公头弯头连接线, 不带屏蔽

Scale drawing/尺寸图

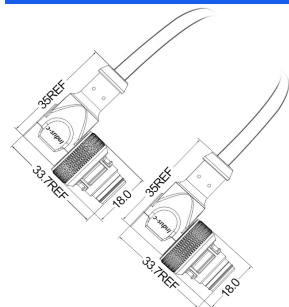

Product photo/产品图



Part number/产品料号

Pins/针数	Code/型	Part number("X" is length millimetre mm)/产品料号("X"表示长度, 单位毫米mm)	
		PVC jacket/PVC外被 -40°C~+105°C	PUR jacket/PUR外被 -40°C~+105°C
3pins/3针	A code/A型	12L01908	12L01909
4pins/4针	A code/A型	12L01928	12L01929
5pins/5针	A code/A型	12L01948	12L01949
8pins/8针	A code/A型	12L01968	12L01969
12pins/12针	A code/A型	12L01988	12L01989

Pin assignment front view/针位分布前视图

A code 3pins A code 4pins A code 5pins A code 8pins A code 12pins
A型3针 A型4针 A型5针 A型8针 A型12针

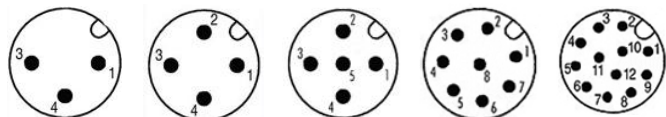

General data/常规数据

Pin Numbers/针数	3pins/3针	4pins/4针	5pins/5针	8pins/8针	12pins/12针
Rated voltage/额定电压	250V		60V	30V	
Rated current(40°C)/额定电流	4A			2A	1.5A
Standards/标准	IEC 61076-2-101				
Termination/焊接方式	Solder PCB/PCB焊接				
Connector locking system/锁紧方式	Push-pull/快锁				
Degree of protection/防护等级	IP67, IP68, IP69K				
Mechanical operation/插拔次数	>100 mating cycles/大于100次				
Ambient temperature (operation)/操作温度	-25°C~+85°C				
Contact resistance/接触电阻	≤5mΩ				
Insulation resistance/绝缘电阻	≥100MΩ				
Connector body/胶芯	TPU				
Pin/端子	Brass with gold plated/黄铜镀金				
Screw/螺丝	Brass with nickel plated/黄铜镀镍				
Over-mold/成型	TPU				
Customs tariff number/海关编码	8518900001				
Environmental compliance/环境符合标准	RoHs, Reach				

Push-pull m12 A code male to female right angle molded cable, unshielded/推拉式M12, A型公头弯头对母头弯头连接线, 不带屏蔽

Scale drawing/尺寸图

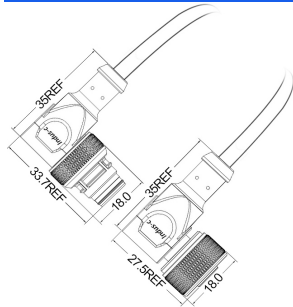

Product photo/产品图



Part number/产品料号

Pins/针数	Code/型	Part number("X" is length millimetre mm)/产品料号("X"表示长度, 单位毫米mm)	
		PVC jacket/PVC外被 -40°C~+105°C	PUR jacket/PUR外被 -40°C~+105°C
3pins/3针	A code/A型	12L01910	12L01911
4pins/4针	A code/A型	12L01930	12L01931
5pins/5针	A code/A型	12L01950	12L01951
8pins/8针	A code/A型	12L01970	12L01971
12pins/12针	A code/A型	12L01990	12L01991

Pin assignment front view/针位分布前视图

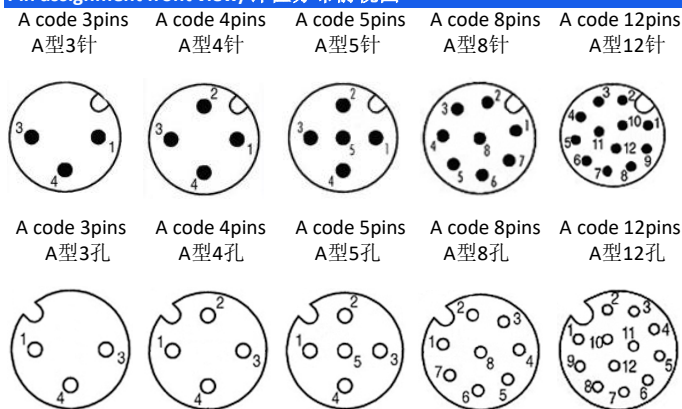

General data/常规数据

Pin Numbers/针数	3pins/3针	4pins/4针	5pins/5针	8pins/8针	12pins/12针
Rated voltage/额定电压	250V		60V	30V	
Rated current(40°C)/额定电流	4A			2A	1.5A
Standards/标准	IEC 61076-2-101				
Termination/焊接方式	Solder PCB/PCB焊接				
Connector locking system/锁紧方式	Push-pull/快锁				
Degree of protection/防护等级	IP67, IP68, IP69K				
Mechanical operation/插拔次数	>100 mating cycles/大于100次				
Ambient temperature (operation)/操作温度	-25°C~+85°C				
Contact resistance/接触电阻	≤5mΩ				
Insulation resistance/绝缘电阻	≥100MΩ				
Connector body/胶芯	TPU				
Male pin/公端子	Brass with gold plated/黄铜镀金				
Female pin/母端子	Phosphorus copper with gold plated/磷铜镀金				
Screw/螺丝	Brass with nickel plated/黄铜镀镍				
Over-mold/成型	TPU				
Shielded shell/屏蔽罩	Brass with nickel plated/黄铜镀镍				
Customs tariff number/海关编码	8518900001				
Environmental compliance/环境符合标准	RoHs, Reach				

Push-pull m12 A code male right angle to female straight molded cable, unshielded/推拉式M12, A型公头弯头对母头直头成型式连接线, 不带屏蔽

Scale drawing/尺寸图

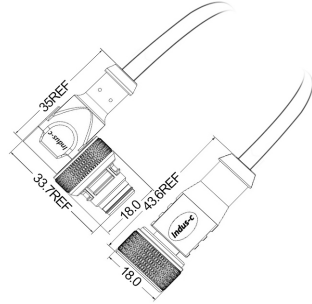

Product photo/产品图



Part number/产品料号

Pins/针数	Code/型	Part number("X" is length millimetre mm)/产品料号("X"表示长度, 单位毫米mm)	
		PVC jacket/PVC外被 -40°C~+105°C	PUR jacket/PUR外被 -40°C~+105°C
3pins/3针	A code/A型	12L01912	12L01913
4pins/4针	A code/A型	12L01932	12L01933
5pins/5针	A code/A型	12L01952	12L01953
8pins/8针	A code/A型	12L01972	12L01973
12pins/12针	A code/A型	12L01992	12L01993

Pin assignment front view/针位分布前视图

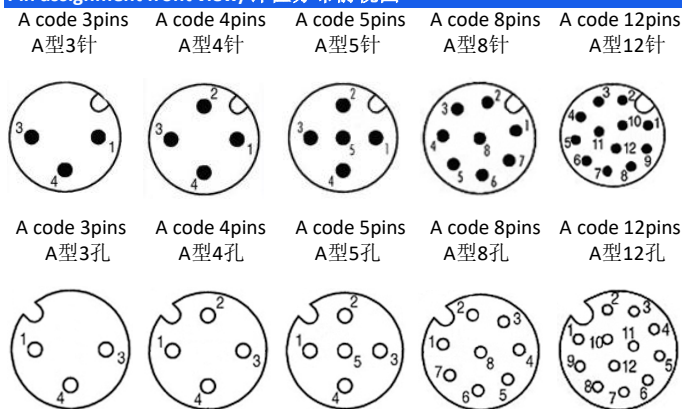

General data/常规数据

Pin Numbers/针数	3pins/3针	4pins/4针	5pins/5针	8pins/8针	12pins/12针
Rated voltage/额定电压	250V		60V	30V	
Rated current(40°C)/额定电流	4A			2A	1.5A
Standards/标准	IEC 61076-2-101				
Termination/焊接方式	Solder PCB/PCB焊接				
Connector locking system/锁紧方式	Push-pull/快锁				
Degree of protection/防护等级	IP67, IP68, IP69K				
Mechanical operation/插拔次数	>100 mating cycles/大于100次				
Ambient temperature (operation)/操作温度	-25°C~+85°C				
Contact resistance/接触电阻	≤5mΩ				
Insulation resistance/绝缘电阻	≥100MΩ				
Connector body/胶芯	TPU				
Male pin/公端子	Brass with gold plated/黄铜镀金				
Female pin/母端子	Phosphorus copper with gold plated/磷铜镀金				
Screw/螺丝	Brass with nickel plated/黄铜镀镍				
Over-mold/成型	TPU				
Shielded shell/屏蔽罩	Brass with nickel plated/黄铜镀镍				
Customs tariff number/海关编码	8518900001				
Environmental compliance/环境符合标准	RoHs, Reach				

Push-pull m12 A code male straight to male right angle molded cable, unshielded/推拉式M12, A型公头直头对公头弯头连接线, 不带屏蔽

Scale drawing/尺寸图

Product photo/产品图

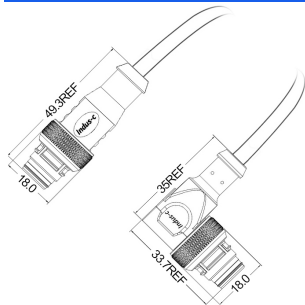

Part number/产品料号

Pins/针数	Code/型	Part number("X" is length millimetre mm)/产品料号("X"表示长度, 单位毫米mm)	
		PVC jacket/PVC外被 -40°C~+105°C	PUR jacket/PUR外被 -40°C~+105°C
3pins/3针	A code/A型	12L01914	12L01915
4pins/4针	A code/A型	12L01934	12L01935
5pins/5针	A code/A型	12L01954	12L01955
8pins/8针	A code/A型	12L01974	12L01975
12pins/12针	A code/A型	12L01994	12L01995

Pin assignment front view/针位分布前视图

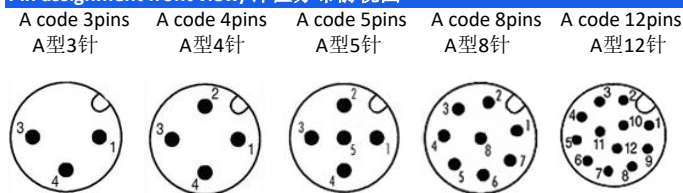

General data/常规数据

Pin Numbers/针数	3pins/3针	4pins/4针	5pins/5针	8pins/8针	12pins/12针
Rated voltage/额定电压	250V		60V	30V	
Rated current(40°C)/额定电流	4A			2A	1.5A
Standards/标准	IEC 61076-2-101				
Termination/焊接方式	Solder PCB/PCB焊接				
Connector locking system/锁紧方式	Push-pull/快锁				
Degree of protection/防护等级	IP67, IP68, IP69K				
Mechanical operation/插拔次数	>100 mating cycles/大于100次				
Ambient temperature (operation)/操作温度	-25°C~+85°C				
Contact resistance/接触电阻	≤5mΩ				
Insulation resistance/绝缘电阻	≥100MΩ				
Connector body/胶芯	TPU				
Pin/端子	Brass with gold plated/黄铜镀金				
Screw/螺丝	Brass with nickel plated/黄铜镀镍				
Over-mold/成型	TPU				
Customs tariff number/海关编码	8518900001				
Environmental compliance/环境符合标准	RoHs, Reach				

Push-pull m12 A code male to male straight molded cable, unshielded/推拉式M12, A型公头直头对公头直头连接线, 不带屏蔽

Scale drawing/尺寸图

Product photo/产品图

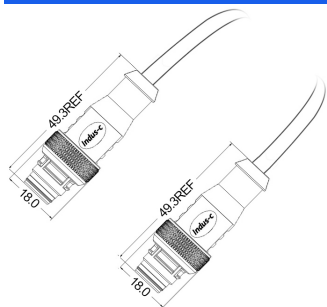

Part number/产品料号

Pins/针数	Code/型	Part number("X" is length millimetre mm)/产品料号("X"表示长度, 单位毫米mm)	
		PVC jacket/PVC外被 -40°C~+105°C	PUR jacket/PUR外被 -40°C~+105°C
3pins/3针	A code/A型	12L01916	12L01917
4pins/4针	A code/A型	12L01936	12L01937
5pins/5针	A code/A型	12L01956	12L01957
8pins/8针	A code/A型	12L01976	12L01977
12pins/12针	A code/A型	12L01996	12L01997

Pin assignment front view/针位分布前视图

A code 3pins A code 4pins A code 5pins A code 8pins A code 12pins
A型3针 A型4针 A型5针 A型8针 A型12针

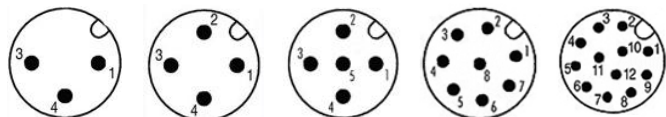

General data/常规数据

Pin Numbers/针数	3pins/3针	4pins/4针	5pins/5针	8pins/8针	12pins/12针
Rated voltage/额定电压	250V		60V	30V	
Rated current(40°C)/额定电流	4A			2A	1.5A
Standards/标准	IEC 61076-2-101				
Termination/焊接方式	Solder PCB/PCB焊接				
Connector locking system/锁紧方式	Push-pull/快锁				
Degree of protection/防护等级	IP67, IP68, IP69K				
Mechanical operation/插拔次数	>100 mating cycles/大于100次				
Ambient temperature (operation)/操作温度	-25°C~+85°C				
Contact resistance/接触电阻	≤5mΩ				
Insulation resistance/绝缘电阻	≥100MΩ				
Connector body/胶芯	TPU				
Pin/端子	Brass with gold plated/黄铜镀金				
Screw/螺丝	Brass with nickel plated/黄铜镀镍				
Over-mold/成型	TPU				
Customs tariff number/海关编码	8518900001				
Environmental compliance/环境符合标准	RoHs, Reach				

Push-pull m12 A code male straight to female right angle molded cable, unshielded/推拉式M12, A型公头直头对母头弯头连接线, 不带屏蔽

Scale drawing/尺寸图

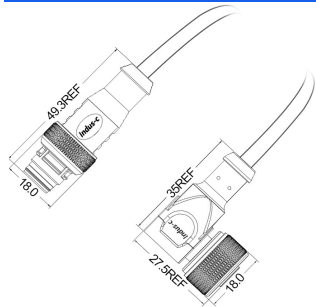

Product photo/产品图



Part number/产品料号

Pins/针数	Code/型	Part number("X" is length millimetre mm)/产品料号("X"表示长度, 单位毫米mm)	
		PVC jacket/PVC外被 -40°C~+105°C	PUR jacket/PUR外被 -40°C~+105°C
3pins/3针	A code/A型	12L01918	12L01919
4pins/4针	A code/A型	12L01938	12L01939
5pins/5针	A code/A型	12L01958	12L01959
8pins/8针	A code/A型	12L01978	12L01979
12pins/12针	A code/A型	12L01998	12L01999

Pin assignment front view/针位分布前视图

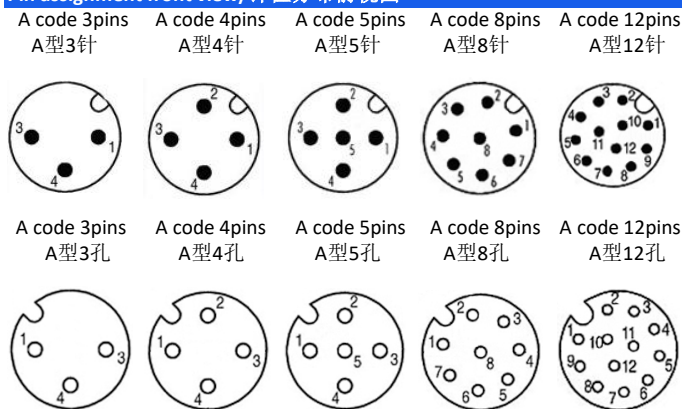

General data/常规数据

Pin Numbers/针数	3pins/3针	4pins/4针	5pins/5针	8pins/8针	12pins/12针
Rated voltage/额定电压	250V		60V	30V	
Rated current(40°C)/额定电流	4A			2A	1.5A
Standards/标准	IEC 61076-2-101				
Termination/焊接方式	Solder PCB/PCB焊接				
Connector locking system/锁紧方式	Push-pull/快锁				
Degree of protection/防护等级	IP67, IP68, IP69K				
Mechanical operation/插拔次数	>100 mating cycles/大于100次				
Ambient temperature (operation)/操作温度	-25°C~+85°C				
Contact resistance/接触电阻	≤5mΩ				
Insulation resistance/绝缘电阻	≥100MΩ				
Connector body/胶芯	TPU				
Male pin/公端子	Brass with gold plated/黄铜镀金				
Female pin/母端子	Phosphorus copper with gold plated/磷铜镀金				
Screw/螺丝	Brass with nickel plated/黄铜镀镍				
Over-mold/成型	TPU				
Shielded shell/屏蔽罩	Brass with nickel plated/黄铜镀镍				
Customs tariff number/海关编码	8518900001				
Environmental compliance/环境符合标准	RoHs, Reach				

Push-pull m12 A code male to female straight molded cable, unshielded/推拉式M12, A型公头直头对母头直头连接线, 不带屏蔽

Scale drawing/尺寸图

Product photo/产品图

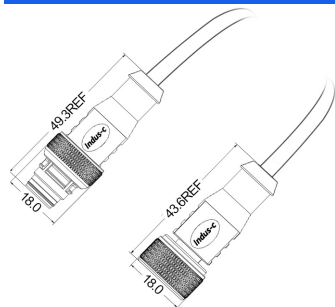

Part number/产品料号

Pins/针数	Code/型	Part number("X" is length millimetre mm)/产品料号("X"表示长度, 单位毫米mm)	
		PVC jacket/PVC外被 -40°C~+105°C	PUR jacket/PUR外被 -40°C~+105°C
3pins/3针	A code/A型	12L01920	12L01921
4pins/4针	A code/A型	12L01940	12L01941
5pins/5针	A code/A型	12L01960	12L01961
8pins/8针	A code/A型	12L01980	12L01981
12pins/12针	A code/A型	12L02000	12L02001

Pin assignment front view/针位分布前视图

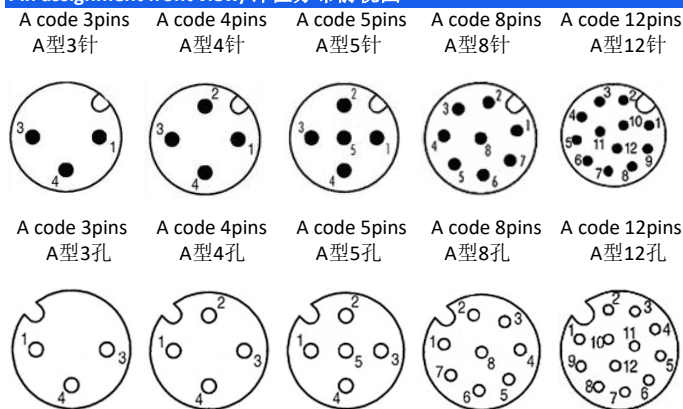

General data/常规数据

Pin Numbers/针数	3pins/3针	4pins/4针	5pins/5针	8pins/8针	12pins/12针
Rated voltage/额定电压	250V		60V	30V	
Rated current(40°C)/额定电流	4A			2A	1.5A
Standards/标准	IEC 61076-2-101				
Termination/焊接方式	Solder PCB/PCB焊接				
Connector locking system/锁紧方式	Push-pull/快锁				
Degree of protection/防护等级	IP67, IP68, IP69K				
Mechanical operation/插拔次数	>100 mating cycles/大于100次				
Ambient temperature (operation)/操作温度	-25°C~+85°C				
Contact resistance/接触电阻	≤5mΩ				
Insulation resistance/绝缘电阻	≥100MΩ				
Connector body/胶芯	TPU				
Male pin/公端子	Brass with gold plated/黄铜镀金				
Female pin/母端子	Phosphorus copper with gold plated/磷铜镀金				
Screw/螺丝	Brass with nickel plated/黄铜镀镍				
Over-mold/成型	TPU				
Shielded shell/屏蔽罩	Brass with nickel plated/黄铜镀镍				
Customs tariff number/海关编码	8518900001				
Environmental compliance/环境符合标准	RoHs, Reach				

Push-pull m12 A code female to female right angle molded cable, unshielded/推拉式M12, A型母头弯头对母头弯头连接线, 不带屏蔽

Scale drawing/尺寸图

Product photo/产品图

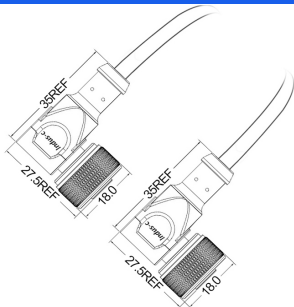

Part number/产品料号

Pins/针数	Code/型	Part number("X" is length millimetre mm)/产品料号("X"表示长度, 单位毫米mm)	
		PVC jacket/PVC外被 -40°C~+105°C	PUR jacket/PUR外被 -40°C~+105°C
3pins/3针	A code/A型	12L01922	12L01923
4pins/4针	A code/A型	12L01942	12L01943
5pins/5针	A code/A型	12L01962	12L01963
8pins/8针	A code/A型	12L01982	12L01983
12pins/12针	A code/A型	12L02002	12L02003

Pin assignment front view/针位分布前视图

A code 3pins A code 4pins A code 5pins A code 8pins A code 12pins
A型3孔 A型4孔 A型5孔 A型8孔 A型12孔

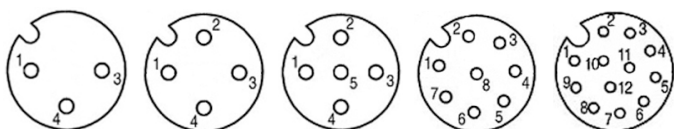

General data/常规数据

Pin Numbers/孔数	3pins/3孔	4pins/4孔	5pins/5孔	8pins/8孔	12pins/12孔
Rated voltage/额定电压	250V		60V	30V	
Rated current(40°C)/额定电流	4A			2A	1.5A
Standards/标准	IEC 61076-2-101				
Termination/焊接方式	Solder PCB/PCB焊接				
Connector locking system/锁紧方式	Push-pull/快锁				
Degree of protection/防护等级	IP67, IP68, IP69K				
Mechanical operation/插拔次数	>100 mating cycles/大于100次				
Ambient temperature (operation)/操作温度	-25°C~+85°C				
Contact resistance/接触电阻	≤5mΩ				
Insulation resistance/绝缘电阻	≥100MΩ				
Connector body/胶芯	TPU				
Pin/端子	Phosphorus copper with gold plated/磷铜镀金				
Screw/螺丝	Brass with nickel plated/黄铜镀镍				
Over-mold/成型	TPU				
Gasket/胶圈	Fluorine ring/氟胶圈				
Customs tariff number/海关编码	8518900001				
Environmental compliance/环境符合标准	RoHs, Reach				

Push-pull m12 A code female straight to female right angle molded cable, unshielded/推拉式M12, A型母头直头对母头弯头连接线, 不带屏蔽

Scale drawing/尺寸图

Product photo/产品图

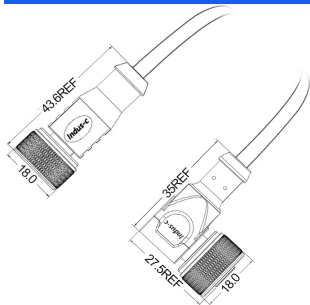

Part number/产品料号

Pins/针数	Code/型	Part number("X" is length millimetre mm)/产品料号("X"表示长度, 单位毫米mm)	
		PVC jacket/PVC外被 -40°C~+105°C	PUR jacket/PUR外被 -40°C~+105°C
3pins/3针	A code/A型	12L01924	12L01925
4pins/4针	A code/A型	12L01944	12L01945
5pins/5针	A code/A型	12L01964	12L01965
8pins/8针	A code/A型	12L01984	12L01985
12pins/12针	A code/A型	12L02004	12L02005

Pin assignment front view/针位分布前视图

A code 3pins A code 4pins A code 5pins A code 8pins A code 12pins
A型3孔 A型4孔 A型5孔 A型8孔 A型12孔

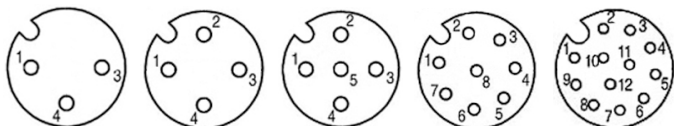

General data/常规数据

Pin Numbers/孔数	3pins/3孔	4pins/4孔	5pins/5孔	8pins/8孔	12pins/12孔
Rated voltage/额定电压	250V		60V	30V	
Rated current(40°C)/额定电流	4A			2A	1.5A
Standards/标准	IEC 61076-2-101				
Termination/焊接方式	Solder PCB/PCB焊接				
Connector locking system/锁紧方式	Push-pull/快锁				
Degree of protection/防护等级	IP67, IP68, IP69K				
Mechanical operation/插拔次数	>100 mating cycles/大于100次				
Ambient temperature (operation)/操作温度	-25°C~+85°C				
Contact resistance/接触电阻	≤5mΩ				
Insulation resistance/绝缘电阻	≥100MΩ				
Connector body/胶芯	TPU				
Pin/端子	Phosphorus copper with gold plated/磷铜镀金				
Screw/螺丝	Brass with nickel plated/黄铜镀镍				
Over-mold/成型	TPU				
Gasket/胶圈	Fluorine ring/氟胶圈				
Customs tariff number/海关编码	8518900001				
Environmental compliance/环境符合标准	RoHs, Reach				

Push-pull m12 A code female to female straight molded cable, unshielded/推拉式M12, A型母头直头对母头直头连接线, 不带屏蔽

Scale drawing/尺寸图

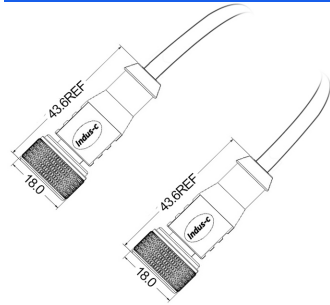

Product photo/产品图



Part number/产品料号

Pins/针数	Code/型	Part number("X" is length millimetre mm)/产品料号("X"表示长度, 单位毫米mm)	
		PVC jacket/PVC外被 -40°C~+105°C	PUR jacket/PUR外被 -40°C~+105°C
3pins/3针	A code/A型	12L01926	12L01927
4pins/4针	A code/A型	12L01946	12L01947
5pins/5针	A code/A型	12L01966	12L01967
8pins/8针	A code/A型	12L01986	12L01987
12pins/12针	A code/A型	12L02006	12L02007

Pin assignment front view/针位分布前视图

A code 3pins A型3孔 A code 4pins A型4孔 A code 5pins A型5孔 A code 8pins A型8孔 A code 12pins A型12孔

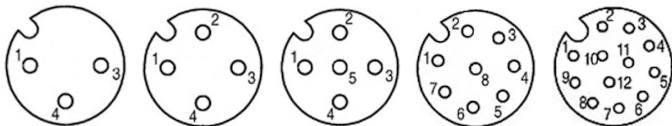

General data/常规数据

Pin Numbers/孔数	3pins/3孔	4pins/4孔	5pins/5孔	8pins/8孔	12pins/12孔
Rated voltage/额定电压	250V		60V	30V	
Rated current(40°C)/额定电流	4A			2A	1.5A
Standards/标准	IEC 61076-2-101				
Termination/焊接方式	Solder PCB/PCB焊接				
Connector locking system/锁紧方式	Push-pull/快锁				
Degree of protection/防护等级	IP67, IP68, IP69K				
Mechanical operation/插拔次数	>100 mating cycles/大于100次				
Ambient temperature (operation)/操作温度	-25°C~+85°C				
Contact resistance/接触电阻	≤5mΩ				
Insulation resistance/绝缘电阻	≥100MΩ				
Connector body/胶芯	TPU				
Pin/端子	Phosphorus copper with gold plated/磷铜镀金				
Screw/螺丝	Brass with nickel plated/黄铜镀镍				
Over-mold/成型	TPU				
Gasket/胶圈	Fluorine ring/氟胶圈				
Customs tariff number/海关编码	8518900001				
Environmental compliance/环境符合标准	RoHs, Reach				

Push-pull m12 A code male straight molded cable, shielded/推拉式M12, A型公头直头成型式连接线, 带屏蔽

Scale drawing/尺寸图

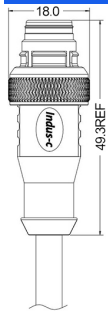

Product photo/产品图



Part number/产品料号

Pins/针数	Code/型	Part number("X" is length millimetre mm)/产品料号("X"表示长度, 单位毫米mm)	
		PVC jacket/PVC外被 -40°C~+105°C	PUR jacket/PUR外被 -40°C~+105°C
3pins/3针	A code/A型	12L01868	12L01869
4pins/4针	A code/A型	12L01876	12L01877
5pins/5针	A code/A型	12L01884	12L01885
8pins/8针	A code/A型	12L01892	12L01893
12pins/12针	A code/A型	12L01900	12L01901

Pin assignment front view/针位分布前视图

A code 3pins A code 4pins A code 5pins A code 8pins A code 12pins
 A型3针 A型4针 A型5针 A型8针 A型12针

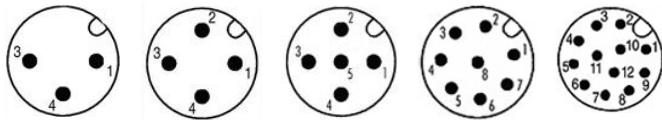

General data/常规数据

Pin Numbers/针数	3pins/3针	4pins/4针	5pins/5针	8pins/8针	12pins/12针
Rated voltage/额定电压	250V		60V	30V	
Rated current(40°C)/额定电流	4A			2A	1.5A
Standards/标准	IEC 61076-2-101				
Termination/焊接方式	Solder PCB/PCB焊接				
Connector locking system/锁紧方式	Push-pull/快锁				
Degree of protection/防护等级	IP67, IP68, IP69K				
Mechanical operation/插拔次数	>100 mating cycles/大于100次				
Ambient temperature (operation)/操作温度	-25°C~+85°C				
Contact resistance/接触电阻	≤5mΩ				
Insulation resistance/绝缘电阻	≥100MΩ				
Connector body/胶芯	TPU				
Pin/端子	Brass with gold plated/黄铜镀金				
Screw/螺丝	Brass with nickel plated/黄铜镀镍				
Over-mold/成型	TPU				
Customs tariff number/海关编码	8518900001				
Environmental compliance/环境符合标准	RoHs, Reach				

Push-pull m12 A code female straight molded cable, shielded/推拉式M12, A型母头直头成型式连接线, 带屏蔽

Scale drawing/尺寸图

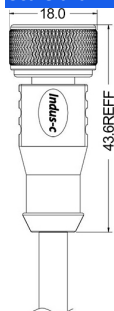

Product photo/产品图



Part number/产品料号

Pins/针数	Code/型	Part number("X" is length millimetre mm)/产品料号("X"表示长度, 单位毫米mm)	
		PVC jacket/PVC外被 -40°C~+105°C	PUR jacket/PUR外被 -40°C~+105°C
3pins/3针	A code/A型	12L01870	12L01871
4pins/4针	A code/A型	12L01878	12L01879
5pins/5针	A code/A型	12L01886	12L01887
8pins/8针	A code/A型	12L01894	12L01895
12pins/12针	A code/A型	12L01902	12L01903

Pin assignment front view/针位分布前视图

A code 3pins A code 4pins A code 5pins A code 8pins A code 12pins
A型3孔 A型4孔 A型5孔 A型8孔 A型12孔

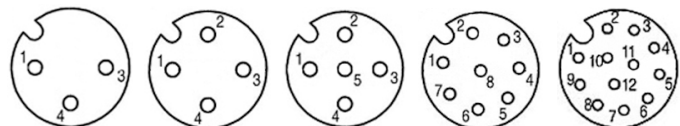

General data/常规数据

Pin Numbers/孔数	3pins/3孔	4pins/4孔	5pins/5孔	8pins/8孔	12pins/12孔
Rated voltage/额定电压	250V		60V	30V	
Rated current(40°C)/额定电流	4A			2A	1.5A
Standards/标准	IEC 61076-2-101				
Termination/焊接方式	Solder PCB/PCB焊接				
Connector locking system/锁紧方式	Push-pull/快锁				
Degree of protection/防护等级	IP67, IP68, IP69K				
Mechanical operation/插拔次数	>100 mating cycles/大于100次				
Ambient temperature (operation)/操作温度	-25°C~+85°C				
Contact resistance/接触电阻	≤5mΩ				
Insulation resistance/绝缘电阻	≥100MΩ				
Connector body/胶芯	TPU				
Pin/端子	Phosphorus copper with gold plated/磷铜镀金				
Screw/螺丝	Brass with nickel plated/黄铜镀镍				
Over-mold/成型	TPU				
Gasket/胶圈	Fluorine ring/氟胶圈				
Customs tariff number/海关编码	8518900001				
Environmental compliance/环境符合标准	RoHs, Reach				

Push-pull m12 A code male right angle molded cable, shielded/推拉式M12, A型公头弯头成型式连接线, 带屏蔽

Scale drawing/尺寸图

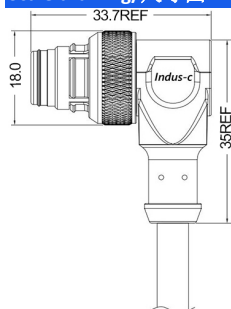

Product photo/产品图



Part number/产品料号

Pins/针数	Code/型	Part number("X" is length millimetre mm)/产品料号("X"表示长度, 单位毫米mm)	
		PVC jacket/PVC外被 -40°C~+105°C	PUR jacket/PUR外被 -40°C~+105°C
3pins/3针	A code/A型	12L01872	12L01873
4pins/4针	A code/A型	12L01880	12L01881
5pins/5针	A code/A型	12L01888	12L01889
8pins/8针	A code/A型	12L01896	12L01897
12pins/12针	A code/A型	12L01904	12L01905

Pin assignment front view/针位分布前视图

A code 3pins A code 4pins A code 5pins A code 8pins A code 12pins
A型3针 A型4针 A型5针 A型8针 A型12针

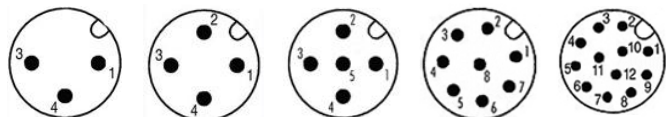

General data/常规数据

Pin Numbers/针数	3pins/3针	4pins/4针	5pins/5针	8pins/8针	12pins/12针
Rated voltage/额定电压	250V		60V	30V	
Rated current(40°C)/额定电流	4A			2A	1.5A
Standards/标准	IEC 61076-2-101				
Termination/焊接方式	Solder PCB/PCB焊接				
Connector locking system/锁紧方式	Push-pull/快锁				
Degree of protection/防护等级	IP67, IP68, IP69K				
Mechanical operation/插拔次数	>100 mating cycles/大于100次				
Ambient temperature (operation)/操作温度	-25°C~+85°C				
Contact resistance/接触电阻	≤5mΩ				
Insulation resistance/绝缘电阻	≥100MΩ				
Connector body/胶芯	TPU				
Pin/端子	Brass with gold plated/黄铜镀金				
Screw/螺丝	Brass with nickel plated/黄铜镀镍				
Over-mold/成型	TPU				
Customs tariff number/海关编码	8518900001				
Environmental compliance/环境符合标准	RoHs, Reach				

Push-pull m12 A code female right angle molded cable, shielded/推拉式M12, A型母头弯头成型式连接线, 带屏蔽

Scale drawing/尺寸图

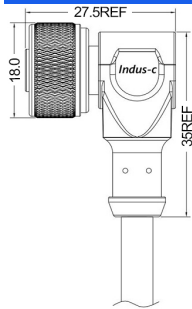

Product photo/产品图



Part number/产品料号

Pins/针数	Code/型	Part number("X" is length millimetre mm)/产品料号("X"表示长度, 单位毫米mm)	
		PVC jacket/PVC外被 -40°C~+105°C	PUR jacket/PUR外被 -40°C~+105°C
3pins/3针	A code/A型	12L01874	12L01875
4pins/4针	A code/A型	12L01882	12L01883
5pins/5针	A code/A型	12L01890	12L01891
8pins/8针	A code/A型	12L01898	12L01899
12pins/12针	A code/A型	12L01906	12L01907

Pin assignment front view/针位分布前视图

A code 3pins A型3孔 A code 4pins A型4孔 A code 5pins A型5孔 A code 8pins A型8孔 A code 12pins A型12孔

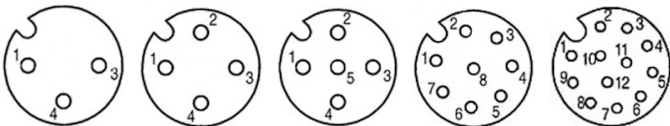

General data/常规数据

Pin Numbers/孔数	3pins/3孔	4pins/4孔	5pins/5孔	8pins/8孔	12pins/12孔
Rated voltage/额定电压	250V		60V	30V	
Rated current(40°C)/额定电流	4A			2A	1.5A
Standards/标准	IEC 61076-2-101				
Termination/焊接方式	Solder PCB/PCB焊接				
Connector locking system/锁紧方式	Push-pull/快锁				
Degree of protection/防护等级	IP67, IP68, IP69K				
Mechanical operation/插拔次数	>100 mating cycles/大于100次				
Ambient temperature (operation)/操作温度	-25°C~+85°C				
Contact resistance/接触电阻	≤5mΩ				
Insulation resistance/绝缘电阻	≥100MΩ				
Connector body/胶芯	TPU				
Pin/端子	Phosphorus copper with gold plated/磷铜镀金				
Screw/螺丝	Brass with nickel plated/黄铜镀镍				
Over-mold/成型	TPU				
Gasket/胶圈	Fluorine ring/氟胶圈				
Customs tariff number/海关编码	8518900001				
Environmental compliance/环境符合标准	RoHs, Reach				

Push-pull m12 A code male to male right angle molded cable, shielded/推拉式M12, A型公头弯头对公头弯头连接线, 带屏蔽

Scale drawing/尺寸图

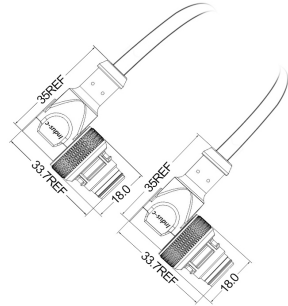

Product photo/产品图



Part number/产品料号

Pins/针数	Code/型	Part number("X" is length millimetre mm)/产品料号("X"表示长度, 单位毫米mm)	
		PVC jacket/PVC外被 -40°C~+105°C	PUR jacket/PUR外被 -40°C~+105°C
3pins/3针	A code/A型	12L02008	12L02009
4pins/4针	A code/A型	12L02028	12L02029
5pins/5针	A code/A型	12L02048	12L02049
8pins/8针	A code/A型	12L02068	12L02069
12pins/12针	A code/A型	12L02088	12L02089

Pin assignment front view/针位分布前视图

A code 3pins A code 4pins A code 5pins A code 8pins A code 12pins
A型3针 A型4针 A型5针 A型8针 A型12针

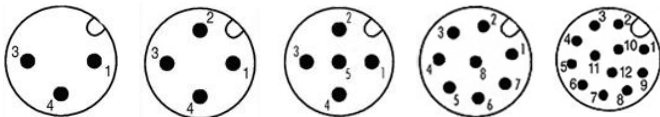

General data/常规数据

Pin Numbers/针数	3pins/3针	4pins/4针	5pins/5针	8pins/8针	12pins/12针
Rated voltage/额定电压	250V		60V	30V	
Rated current(40°C)/额定电流	4A			2A	1.5A
Standards/标准	IEC 61076-2-101				
Termination/焊接方式	Solder PCB/PCB焊接				
Connector locking system/锁紧方式	Push-pull/快锁				
Degree of protection/防护等级	IP67, IP68, IP69K				
Mechanical operation/插拔次数	>100 mating cycles/大于100次				
Ambient temperature (operation)/操作温度	-25°C~+85°C				
Contact resistance/接触电阻	≤5mΩ				
Insulation resistance/绝缘电阻	≥100MΩ				
Connector body/胶芯	TPU				
Pin/端子	Brass with gold plated/黄铜镀金				
Screw/螺丝	Brass with nickel plated/黄铜镀镍				
Over-mold/成型	TPU				
Customs tariff number/海关编码	8518900001				
Environmental compliance/环境符合标准	RoHs, Reach				

Push-pull m12 A code male to female right angle molded cable, shielded/推拉式M12, A型公头弯头对母头弯头连接线, 带屏蔽

Scale drawing/尺寸图

Product photo/产品图

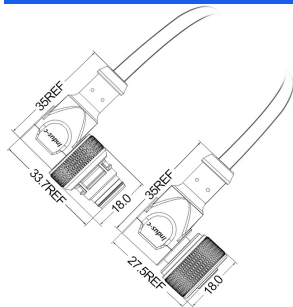

Part number/产品料号

Pins/针数	Code/型	Part number("X" is length millimetre mm)/产品料号("X"表示长度, 单位毫米mm)	
		PVC jacket/PVC外被 -40°C~+105°C	PUR jacket/PUR外被 -40°C~+105°C
3pins/3针	A code/A型	12L02010	12L02011
4pins/4针	A code/A型	12L02030	12L02031
5pins/5针	A code/A型	12L02050	12L02051
8pins/8针	A code/A型	12L02070	12L02071
12pins/12针	A code/A型	12L02090	12L02091

Pin assignment front view/针位分布前视图

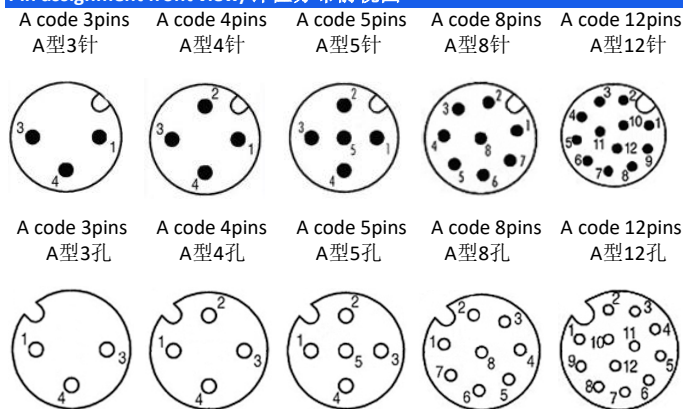

General data/常规数据

Pin Numbers/针数	3pins/3针	4pins/4针	5pins/5针	8pins/8针	12pins/12针
Rated voltage/额定电压	250V		60V	30V	
Rated current(40°C)/额定电流	4A			2A	1.5A
Standards/标准	IEC 61076-2-101				
Termination/焊接方式	Solder PCB/PCB焊接				
Connector locking system/锁紧方式	Push-pull/快锁				
Degree of protection/防护等级	IP67, IP68, IP69K				
Mechanical operation/插拔次数	>100 mating cycles/大于100次				
Ambient temperature (operation)/操作温度	-25°C~+85°C				
Contact resistance/接触电阻	≤5mΩ				
Insulation resistance/绝缘电阻	≥100MΩ				
Connector body/胶芯	TPU				
Male pin/公端子	Brass with gold plated/黄铜镀金				
Female pin/母端子	Phosphorus copper with gold plated/磷铜镀金				
Screw/螺丝	Brass with nickel plated/黄铜镀镍				
Over-mold/成型	TPU				
Shielded shell/屏蔽罩	Brass with nickel plated/黄铜镀镍				
Customs tariff number/海关编码	8518900001				
Environmental compliance/环境符合标准	RoHs, Reach				

Push-pull m12 A code male right angle to female straight molded cable, shielded/推拉式M12, A型公头弯头对母头直头成型式连接线, 带屏蔽

Scale drawing/尺寸图

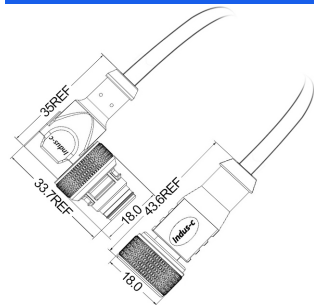

Product photo/产品图



Part number/产品料号

Pins/针数	Code/型	Part number("X" is length millimetre mm)/产品料号("X"表示长度, 单位毫米mm)	
		PVC jacket/PVC外被 -40°C~+105°C	PUR jacket/PUR外被 -40°C~+105°C
3pins/3针	A code/A型	12L02012	12L02013
4pins/4针	A code/A型	12L02032	12L02033
5pins/5针	A code/A型	12L02052	12L02053
8pins/8针	A code/A型	12L02072	12L02073
12pins/12针	A code/A型	12L02092	12L02093

Pin assignment front view/针位分布前视图

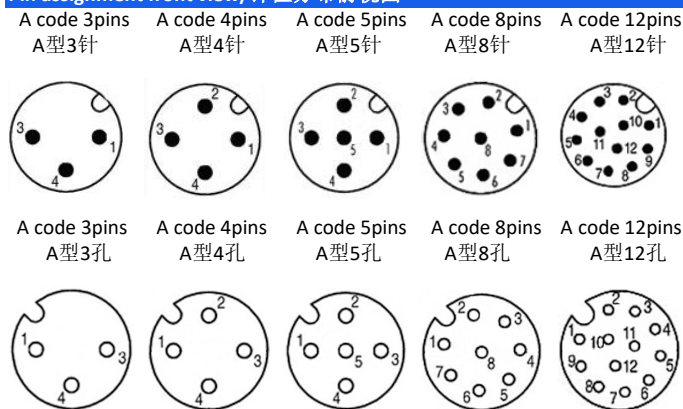

General data/常规数据

Pin Numbers/针数	3pins/3针	4pins/4针	5pins/5针	8pins/8针	12pins/12针
Rated voltage/额定电压	250V		60V	30V	
Rated current(40°C)/额定电流	4A			2A	1.5A
Standards/标准	IEC 61076-2-101				
Termination/焊接方式	Solder PCB/PCB焊接				
Connector locking system/锁紧方式	Push-pull/快锁				
Degree of protection/防护等级	IP67, IP68, IP69K				
Mechanical operation/插拔次数	>100 mating cycles/大于100次				
Ambient temperature (operation)/操作温度	-25°C~+85°C				
Contact resistance/接触电阻	≤5mΩ				
Insulation resistance/绝缘电阻	≥100MΩ				
Connector body/胶芯	TPU				
Male pin/公端子	Brass with gold plated/黄铜镀金				
Female pin/母端子	Phosphorus copper with gold plated/磷铜镀金				
Screw/螺丝	Brass with nickel plated/黄铜镀镍				
Over-mold/成型	TPU				
Shielded shell/屏蔽罩	Brass with nickel plated/黄铜镀镍				
Customs tariff number/海关编码	8518900001				
Environmental compliance/环境符合标准	RoHs, Reach				

Push-pull m12 A code male straight to male right angle molded cable, shielded/推拉式M12, A型公头直头对公头弯头连接线, 带屏蔽

Scale drawing/尺寸图

Product photo/产品图

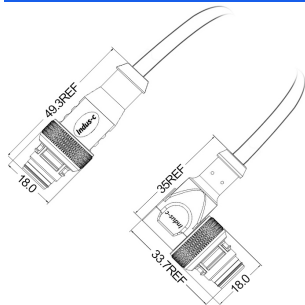

Part number/产品料号

Pins/针数	Code/型	Part number("X" is length millimetre mm)/产品料号("X"表示长度, 单位毫米mm)	
		PVC jacket/PVC外被 -40°C~+105°C	PUR jacket/PUR外被 -40°C~+105°C
3pins/3针	A code/A型	12L02014	12L02015
4pins/4针	A code/A型	12L02034	12L02035
5pins/5针	A code/A型	12L02054	12L02055
8pins/8针	A code/A型	12L02074	12L02075
12pins/12针	A code/A型	12L02094	12L02095

Pin assignment front view/针位分布前视图

A code 3pins A code 4pins A code 5pins A code 8pins A code 12pins
A型3针 A型4针 A型5针 A型8针 A型12针

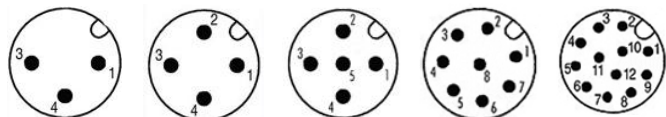

General data/常规数据

Pin Numbers/针数	3pins/3针	4pins/4针	5pins/5针	8pins/8针	12pins/12针
Rated voltage/额定电压	250V		60V	30V	
Rated current(40°C)/额定电流	4A			2A	1.5A
Standards/标准	IEC 61076-2-101				
Termination/焊接方式	Solder PCB/PCB焊接				
Connector locking system/锁紧方式	Push-pull/快锁				
Degree of protection/防护等级	IP67, IP68, IP69K				
Mechanical operation/插拔次数	>100 mating cycles/大于100次				
Ambient temperature (operation)/操作温度	-25°C~+85°C				
Contact resistance/接触电阻	≤5mΩ				
Insulation resistance/绝缘电阻	≥100MΩ				
Connector body/胶芯	TPU				
Pin/端子	Brass with gold plated/黄铜镀金				
Screw/螺丝	Brass with nickel plated/黄铜镀镍				
Over-mold/成型	TPU				
Customs tariff number/海关编码	851890001				
Environmental compliance/环境符合标准	RoHs, Reach				

Push-pull m12 A code male to male straight molded cable, shielded/推拉式M12, A型公头直头对公头直头连接线, 带屏蔽

Scale drawing/尺寸图

Product photo/产品图

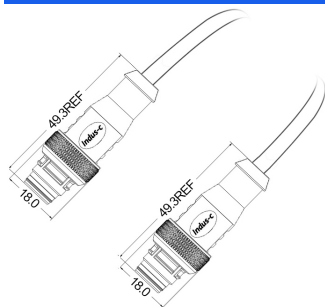

Part number/产品料号

Pins/针数	Code/型	Part number("X" is length millimetre mm)/产品料号("X"表示长度, 单位毫米mm)	
		PVC jacket/PVC外被 -40°C~+105°C	PUR jacket/PUR外被 -40°C~+105°C
3pins/3针	A code/A型	12L02016	12L02017
4pins/4针	A code/A型	12L02036	12L02037
5pins/5针	A code/A型	12L02056	12L02057
8pins/8针	A code/A型	12L02076	12L02077
12pins/12针	A code/A型	12L02096	12L02097

Pin assignment front view/针位分布前视图

A code 3pins A code 4pins A code 5pins A code 8pins A code 12pins
A型3针 A型4针 A型5针 A型8针 A型12针

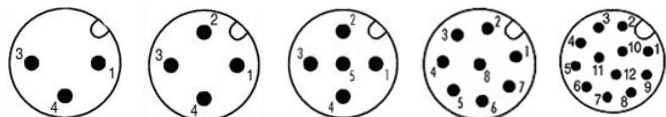

General data/常规数据

Pin Numbers/针数	3pins/3针	4pins/4针	5pins/5针	8pins/8针	12pins/12针
Rated voltage/额定电压	250V		60V	30V	
Rated current(40°C)/额定电流	4A			2A	1.5A
Standards/标准	IEC 61076-2-101				
Termination/焊接方式	Solder PCB/PCB焊接				
Connector locking system/锁紧方式	Push-pull/快锁				
Degree of protection/防护等级	IP67, IP68, IP69K				
Mechanical operation/插拔次数	>100 mating cycles/大于100次				
Ambient temperature (operation)/操作温度	-25°C~+85°C				
Contact resistance/接触电阻	≤5mΩ				
Insulation resistance/绝缘电阻	≥100MΩ				
Connector body/胶芯	TPU				
Pin/端子	Brass with gold plated/黄铜镀金				
Screw/螺丝	Brass with nickel plated/黄铜镀镍				
Over-mold/成型	TPU				
Customs tariff number/海关编码	8518900001				
Environmental compliance/环境符合标准	RoHs, Reach				

Push-pull m12 A code male straight to female right angle molded cable, shielded/推拉式M12, A型公头直头对母头弯头连接线, 带屏蔽

Scale drawing/尺寸图

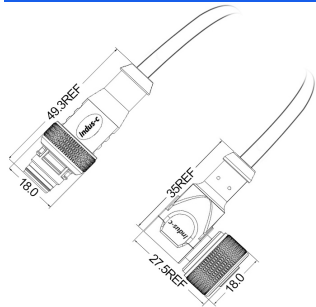

Product photo/产品图



Part number/产品料号

Pins/针数	Code/型	Part number("X" is length millimetre mm)/产品料号("X"表示长度, 单位毫米mm)	
		PVC jacket/PVC外被 -40°C~+105°C	PUR jacket/PUR外被 -40°C~+105°C
3pins/3针	A code/A型	12L02018	12L02019
4pins/4针	A code/A型	12L02038	12L02039
5pins/5针	A code/A型	12L02058	12L02059
8pins/8针	A code/A型	12L02078	12L02079
12pins/12针	A code/A型	12L02098	12L02099

Pin assignment front view/针位分布前视图

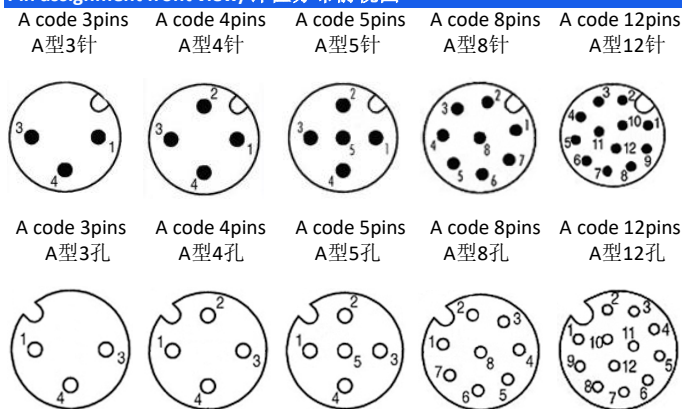

General data/常规数据

Pin Numbers/针数	3pins/3针	4pins/4针	5pins/5针	8pins/8针	12pins/12针
Rated voltage/额定电压	250V		60V	30V	
Rated current(40°C)/额定电流	4A			2A	1.5A
Standards/标准	IEC 61076-2-101				
Termination/焊接方式	Solder PCB/PCB焊接				
Connector locking system/锁紧方式	Push-pull/快锁				
Degree of protection/防护等级	IP67, IP68, IP69K				
Mechanical operation/插拔次数	>100 mating cycles/大于100次				
Ambient temperature (operation)/操作温度	-25°C~+85°C				
Contact resistance/接触电阻	≤5mΩ				
Insulation resistance/绝缘电阻	≥100MΩ				
Connector body/胶芯	TPU				
Male pin/公端子	Brass with gold plated/黄铜镀金				
Female pin/母端子	Phosphorus copper with gold plated/磷铜镀金				
Screw/螺丝	Brass with nickel plated/黄铜镀镍				
Over-mold/成型	TPU				
Shielded shell/屏蔽罩	Brass with nickel plated/黄铜镀镍				
Customs tariff number/海关编码	8518900001				
Environmental compliance/环境符合标准	RoHs, Reach				

Push-pull m12 A code male to female straight molded cable, shielded/推拉式M12, A型公头直头对母头直头连接线, 带屏蔽

Scale drawing/尺寸图

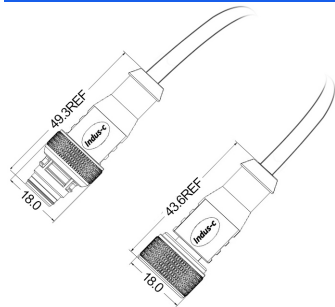

Product photo/产品图



Part number/产品料号

Pins/针数	Code/型	Part number("X" is length millimetre mm)/产品料号("X"表示长度, 单位毫米mm)	
		PVC jacket/PVC外被 -40°C~+105°C	PUR jacket/PUR外被 -40°C~+105°C
3pins/3针	A code/A型	12L02020	12L02021
4pins/4针	A code/A型	12L02040	12L02041
5pins/5针	A code/A型	12L02060	12L02061
8pins/8针	A code/A型	12L02080	12L02081
12pins/12针	A code/A型	12L02100	12L02101

Pin assignment front view/针位分布前视图

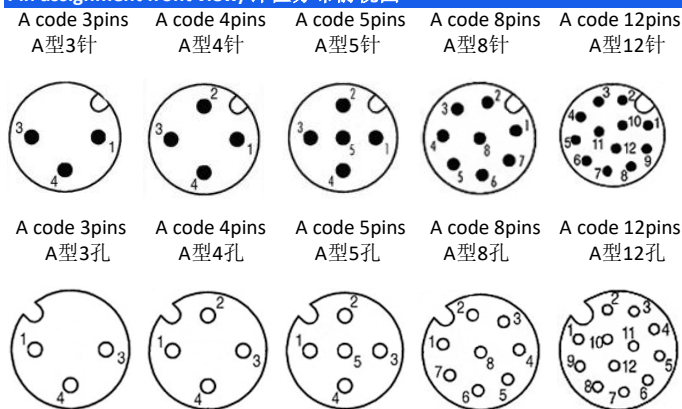

General data/常规数据

Pin Numbers/针数	3pins/3针	4pins/4针	5pins/5针	8pins/8针	12pins/12针
Rated voltage/额定电压	250V		60V	30V	
Rated current(40°C)/额定电流	4A			2A	1.5A
Standards/标准	IEC 61076-2-101				
Termination/焊接方式	Solder PCB/PCB焊接				
Connector locking system/锁紧方式	Push-pull/快锁				
Degree of protection/防护等级	IP67, IP68, IP69K				
Mechanical operation/插拔次数	>100 mating cycles/大于100次				
Ambient temperature (operation)/操作温度	-25°C~+85°C				
Contact resistance/接触电阻	≤5mΩ				
Insulation resistance/绝缘电阻	≥100MΩ				
Connector body/胶芯	TPU				
Male pin/公端子	Brass with gold plated/黄铜镀金				
Female pin/母端子	Phosphorus copper with gold plated/磷铜镀金				
Screw/螺丝	Brass with nickel plated/黄铜镀镍				
Over-mold/成型	TPU				
Shielded shell/屏蔽罩	Brass with nickel plated/黄铜镀镍				
Customs tariff number/海关编码	8518900001				
Environmental compliance/环境符合标准	RoHs, Reach				

Push-pull m12 A code female to female right angle molded cable, shielded/推拉式M12, A型母头弯头对母头弯头连接线, 带屏蔽

Scale drawing/尺寸图

Product photo/产品图

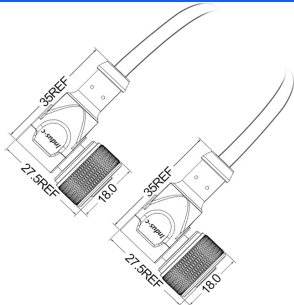

Part number/产品料号

Pins/针数	Code/型	Part number("X" is length millimetre mm)/产品料号("X"表示长度, 单位毫米mm)	
		PVC jacket/PVC外被 -40°C~+105°C	PUR jacket/PUR外被 -40°C~+105°C
3pins/3针	A code/A型	12L02022	12L02023
4pins/4针	A code/A型	12L02042	12L02043
5pins/5针	A code/A型	12L02062	12L02063
8pins/8针	A code/A型	12L02082	12L02083
12pins/12针	A code/A型	12L02102	12L02103

Pin assignment front view/针位分布前视图

A code 3pins A code 4pins A code 5pins A code 8pins A code 12pins
A型3孔 A型4孔 A型5孔 A型8孔 A型12孔

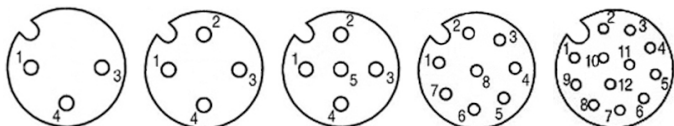

General data/常规数据

Pin Numbers/孔数	3pins/3孔	4pins/4孔	5pins/5孔	8pins/8孔	12pins/12孔
Rated voltage/额定电压	250V		60V	30V	
Rated current(40°C)/额定电流	4A			2A	1.5A
Standards/标准	IEC 61076-2-101				
Termination/焊接方式	Solder PCB/PCB焊接				
Connector locking system/锁紧方式	Push-pull/快锁				
Degree of protection/防护等级	IP67, IP68, IP69K				
Mechanical operation/插拔次数	>100 mating cycles/大于100次				
Ambient temperature (operation)/操作温度	-25°C~+85°C				
Contact resistance/接触电阻	≤5mΩ				
Insulation resistance/绝缘电阻	≥100MΩ				
Connector body/胶芯	TPU				
Pin/端子	Phosphorus copper with gold plated/磷铜镀金				
Screw/螺丝	Brass with nickel plated/黄铜镀镍				
Over-mold/成型	TPU				
Gasket/胶圈	Fluorine ring/氟胶圈				
Customs tariff number/海关编码	8518900001				
Environmental compliance/环境符合标准	RoHs, Reach				

Push-pull m12 A code female straight to female right angle molded cable, shielded/推拉式M12, A型母头直头对母头弯头连接线, 带屏蔽

Scale drawing/尺寸图

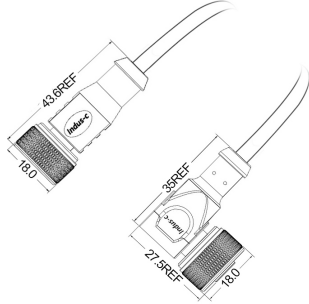

Product photo/产品图



Part number/产品料号

Pins/针数	Code/型	Part number("X" is length millimetre mm)/产品料号("X"表示长度, 单位毫米mm)	
		PVC jacket/PVC外被 -40°C~+105°C	PUR jacket/PUR外被 -40°C~+105°C
3pins/3针	A code/A型	12L02024	12L02025
4pins/4针	A code/A型	12L02044	12L02045
5pins/5针	A code/A型	12L02064	12L02065
8pins/8针	A code/A型	12L02084	12L02085
12pins/12针	A code/A型	12L02104	12L02105

Pin assignment front view/针位分布前视图

A code 3pins A code 4pins A code 5pins A code 8pins A code 12pins
A型3孔 A型4孔 A型5孔 A型8孔 A型12孔

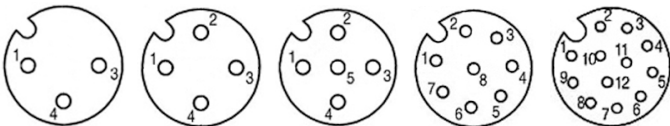

General data/常规数据

Pin Numbers/孔数	3pins/3孔	4pins/4孔	5pins/5孔	8pins/8孔	12pins/12孔
Rated voltage/额定电压	250V		60V	30V	
Rated current(40°C)/额定电流	4A			2A	1.5A
Standards/标准	IEC 61076-2-101				
Termination/焊接方式	Solder PCB/PCB焊接				
Connector locking system/锁紧方式	Push-pull/快锁				
Degree of protection/防护等级	IP67, IP68, IP69K				
Mechanical operation/插拔次数	>100 mating cycles/大于100次				
Ambient temperature (operation)/操作温度	-25°C~+85°C				
Contact resistance/接触电阻	≤5mΩ				
Insulation resistance/绝缘电阻	≥100MΩ				
Connector body/胶芯	TPU				
Pin/端子	Phosphorus copper with gold plated/磷铜镀金				
Screw/螺丝	Brass with nickel plated/黄铜镀镍				
Over-mold/成型	TPU				
Gasket/胶圈	Fluorine ring/氟胶圈				
Customs tariff number/海关编码	8518900001				
Environmental compliance/环境符合标准	RoHs, Reach				

Push-pull m12 A code female to female straight molded cable, shielded/推拉式M12, A型母头直头对母头直头连接线, 带屏蔽

Scale drawing/尺寸图

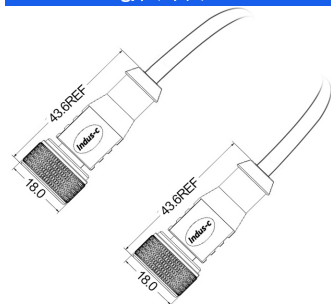

Product photo/产品图



Part number/产品料号

Pins/针数	Code/型	Part number("X" is length millimetre mm)/产品料号("X"表示长度, 单位毫米mm)	
		PVC jacket/PVC外被 -40°C~+105°C	PUR jacket/PUR外被 -40°C~+105°C
3pins/3针	A code/A型	12L02026	12L02027
4pins/4针	A code/A型	12L02046	12L02047
5pins/5针	A code/A型	12L02066	12L02067
8pins/8针	A code/A型	12L02086	12L02087
12pins/12针	A code/A型	12L02106	12L02107

Pin assignment front view/针位分布前视图

A code 3pins A code 4pins A code 5pins A code 8pins A code 12pins
A型3孔 A型4孔 A型5孔 A型8孔 A型12孔

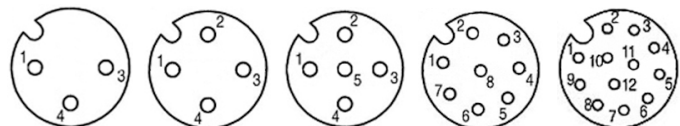

General data/常规数据

Pin Numbers/孔数	3pins/3孔	4pins/4孔	5pins/5孔	8pins/8孔	12pins/12孔
Rated voltage/额定电压	250V		60V	30V	
Rated current(40°C)/额定电流	4A			2A	1.5A
Standards/标准	IEC 61076-2-101				
Termination/焊接方式	Solder PCB/PCB焊接				
Connector locking system/锁紧方式	Push-pull/快锁				
Degree of protection/防护等级	IP67, IP68, IP69K				
Mechanical operation/插拔次数	>100 mating cycles/大于100次				
Ambient temperature (operation)/操作温度	-25°C~+85°C				
Contact resistance/接触电阻	≤5mΩ				
Insulation resistance/绝缘电阻	≥100MΩ				
Connector body/胶芯	TPU				
Pin/端子	Phosphorus copper with gold plated/磷铜镀金				
Screw/螺丝	Brass with nickel plated/黄铜镀镍				
Over-mold/成型	TPU				
Gasket/胶圈	Fluorine ring/氟胶圈				
Customs tariff number/海关编码	8518900001				
Environmental compliance/环境符合标准	RoHs, Reach				